



Project \_\_\_\_\_  
 AIA # \_\_\_\_\_ SIS # \_\_\_\_\_  
 Item # \_\_\_\_\_ Quantity \_\_\_\_\_ C.S.I. Section 114000



## FT2000S BAS STEAM Flight-Type Dishwashing Machine



Complies with EPA Reduction of Lead in Drinking Water Act 2014  
 Meets requirements of ASSE Standard No. 1004

### SPECIFIER STATEMENT

The specified machine will be a Hobart FT2000S BAS flight type dish machine. Features include Complete Delime™ with Delime Notification, Auto Dispensing and Booster Guard™ with dedicated delimer storage location, capless anti-clogging wash arms, insulated ergonomic cabinet style insulated doors, touchscreen controls with WiFi connectivity, an accessible load and unload platforms that open for easy cleaning, 56 gallons of final rinse consumption per hour with dual rinse, and 30" wide conveyor belt.

### STANDARD FEATURES

- + Complete Delime™ with Booster Guard™, Delime Notification, and Auto Dispensing
- + Capless wash arms
- + Water usage 56 gph via pumped final rinse (pressure gauge not required)
- + User-friendly smart touchscreen controls with diagnostics & troubleshooting
- + WiFi connectivity
- + SmartConnect app and cloud with machine status, temperature logs, error code reporting, and cost, consumption and usage analysis
- + Hinged insulated cabinet-style doors with interlocks
- + Load and unload platform with end and removable side panels for ease of cleaning
- + 31" access on prewash/ASR and wash chambers; 20" access on dual/final rinse chamber
- + Start and stop switches at both ends
- + Low temperature alert
- + Dirty water indicator
- + Foot activated drain levers
- + Doors open indicator
- + Drains open indicator
- + 3.5 H.P. prewash and wash pump motors, all TEFC
- + Easy to remove stainless steel scrap pans and baskets with color indicators
- + 30" wide conveyor belt
- + Dual rinse
- + Front and rear enclosure panels
- + 2 selectable conveyor speeds (medium and low)
- + Steam booster heater
- + Field convertible drain to load or unload
- + Service diagnostics

### OPTIONS & ACCESSORIES (Available at extra cost)

- Multiple conveyor options (See page 6)
- Drain Water Tempering Kit
- Factory mounted circuit breakers
- 6" higher than standard chamber
- Flanged feet (field installed)
- Water hammer arrestor kit (field installed)
- WS-80 water softener (field installed)
- Insulated split, vertical slide-up doors
- Correctional packages available

FT SERIES – FT2000S BAS STEAM

Approved by \_\_\_\_\_ Date \_\_\_\_\_ Approved by \_\_\_\_\_ Date \_\_\_\_\_



# FT2000S BAS STEAM Flight-Type Dishwashing Machine

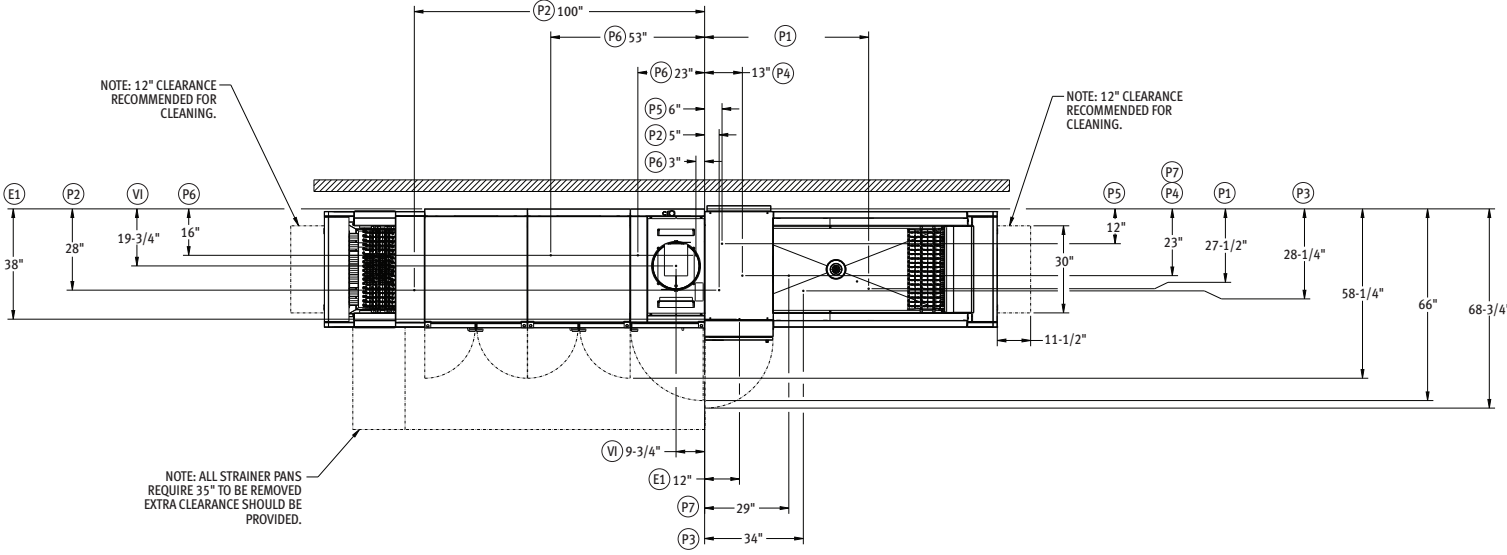

Top View Left to Right

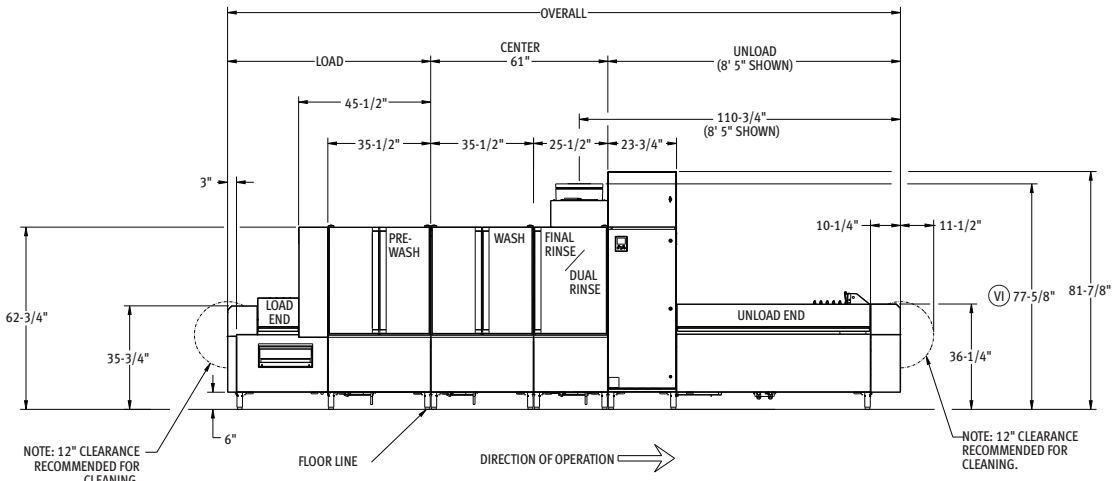

Front View Left to Right

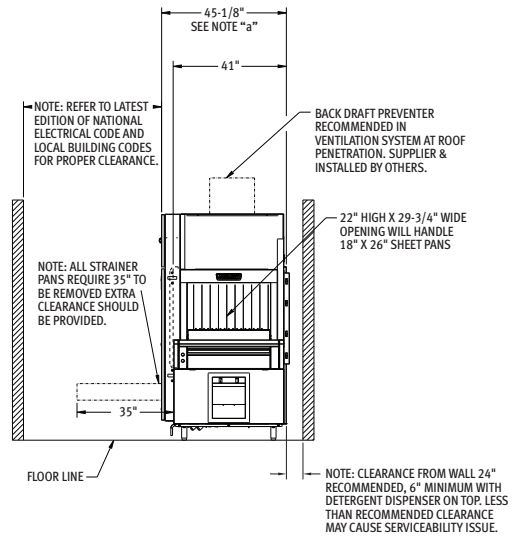

Back/Unload End

CAD and/or Revit Files Available



# FT2000S BAS STEAM Flight-Type Dishwashing Machine

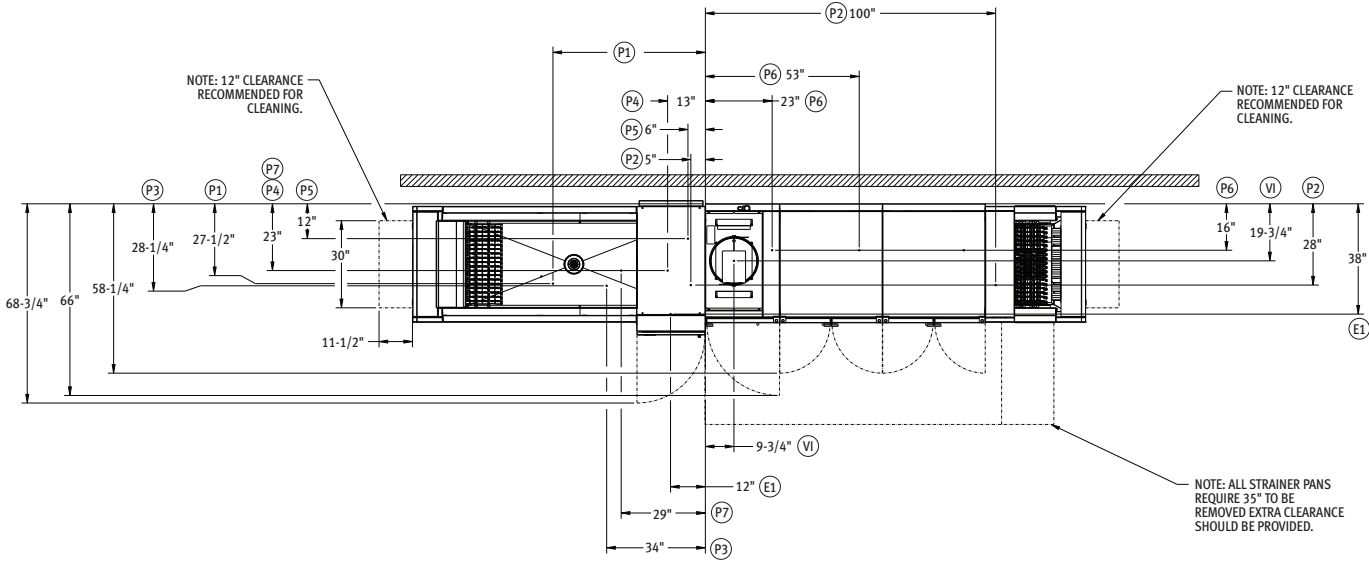

Top View Right to Left

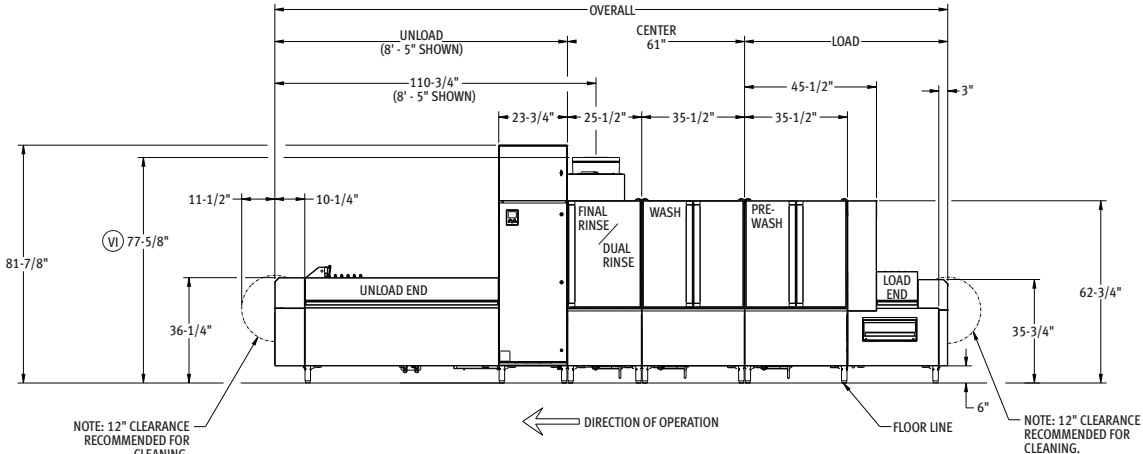

Front View Right to Left

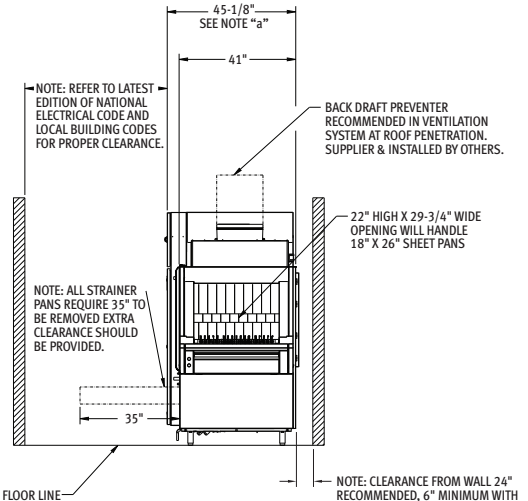

Back/Unload End

➤ CAD and/or Revit Files Available



# FT2000S BAS STEAM

## Flight-Type Dishwashing Machine

### LEGEND

Electrical Connections	
E1	Electric Connection For 1TB With or Without Circuit Breakers. 79" AFF.

### SERVICE CONNECTIONS WITH OR WITHOUT CIRCUIT BREAKERS (1 CONNECTION)

E1	Motors And Controls (1TB) (1) Connection as Shown Below			
	Voltage	Rated Amps	Minimum Supply Circuit Ampacity	Maximum Protective Device
	208-240/60/3	27.6	40	40
	480/60/3	16.7	25	25
	600/60/3	13.7	20	20

### SPECIFICATION

Capacities	
Conveyor Speed (Feet Per Min)	4.0-6.3
Dishes Per Hour	10,611
Pre-Wash Tank (U.S. Gallons)	40
Wash Tank (U.S. Gallons)	40
Dual Rinse Tank (U.S. Gallons)	7.2

Motor HP	
Conveyor Motor	1/3 HP
Pre-Wash Pump	3.5 HP
Wash Pump	3.5 HP
Dual Rinse Pump	1/3 HP
Final Rinse Pump	2/3 HP

Water Consumption	
U.S. Gallons Per Hour	55
U.S. Gallons Per Minute	0.917

Steam Consumption	
Tank Heat	Pounds per hour - 194
Booster Heat	Pounds per hour - 47

Heat Gain to Space IBTU/HRI	
Latent	Sensible
73,800	31,600



# FT2000S BAS STEAM Flight-Type Dishwashing Machine

**WARNING:** Electrical and grounding connections must comply with the applicable portions of the National Electrical Code and/or other local electrical codes.

Plumbing connections must comply with applicable sanitary, safety and plumbing codes. Drain and fill line configurations vary, some methods are shown on this drawing.

#### General Notes:

- (a) This control box is attached to the center section and is rotated 90 degrees allowing the center section to fit through a 42" wide, 7' door opening

With back panel and end caps removed, control panel hinged back and all rear piping removed and door handles removed, overall width of machine is 40"

AFF = above finished floor

For convenience when cleaning customers should install water tap near machine with 30 ft. of heavy duty hose with squeeze valve

This drawing is supplied for a reference for connection information only. It will not be utilized for manufacturing of the unit.

#### Electrical Notes:

Service wire temperature rating: 90°C minimum

SCCR 5KA

Detergent and rinse aid feeder service connections standard on all FT2000 models at machine line voltage

External chemical box service connections standard on all FT2000 models at machine line voltage

Dishmachine not provided with internal GFCI protection

#### Plumbing Notes:

Recommended water hardness to be 3 grains or less per gallon for best results.

Pressure gauge not required on pumped rinse machines.

- (b) Building hot water  
Pressure to the dishwasher is 20–65 PSI
- (c) Water hammer arrestor (meeting ASSE-1010 standard or equivalent) to be supplied (by others) in hot water supply line at service connection
- (d) If flowing steam pressure is 12 PSI and under at the dishwasher, contact sales engineering

#### Ventilation Notes:

Room ventilation is required to handle machine's latent and sensible heat

Vent fan control standard on all FT2000 models

#### Plumbing Connections:

- P1 Common Hot Water Connection (automatic fill) 110°F water minimum, 1" FPT, 6" AFF, see notes (b) and (c)
- P2 Common drain connection: may be drained to either end of the unit. Default location is drain to unload, field convertible to load end 2" FPT, 7" AFF.
- P3 Common steam connection (tank heat & steam booster) 1-1/2" FPT, 7" AFF (13–45 PSI flowing pressure) see note (d).
- P4 Steam relief valve, (when steam booster option is specified) 1" FPT, must be piped to open drain receiver in the floor. 17" AFF
- P5 Hot relief valve, (when steam booster option is specified) 3/4" FPT, must be piped to open drain receiver in the floor. 16" AFF
- P6 Condensate return, gravity connection (tank heat), bucket type traps furnished, 2 connections.  
3/4" FPT, 11" AFF
- P7 Condensate return, gravity connection (when steam booster option is specified) bucket type traps furnished.  
3/4" FPT, 5" AFF

#### Ventilation Requirements:

- VI Customers vent connection must fit inside 16" diameter vent stack providing 750 CFM exhaust at machine connection (standard air conditions) backdraft preventer recommended at roof penetration supplied and installed by others 77-5/8" AFF.

#### Miscellaneous Notes:

LESS THAN RECOMMENDED CLEARANCE MAY CAUSE SERVICEABILITY OR CODE ISSUE.

For optimal performance, Hobart recommends maintaining a dishroom temperature of 65°F (18°C) or higher, as lower temperatures may hinder the machine's capacity to operate effectively (with lower performance as ambient temperature decreases).

All dimensions taken from the floor line may increase 3-1/4" with leg adjustment

For accurate machine shipping weight and dimension information, please reach out to your Hobart customer care representative

Shipping weight varies by individual model

Crated dimensions varies by individual model

For HTS add 6" to chamber height opening

### CONVEYOR TYPE OPTIONS

All conveyors provided with standard polypropylene material. Optional stainless steel conveyors available by request. Please contact your sales representative for stainless steel conveyor options.

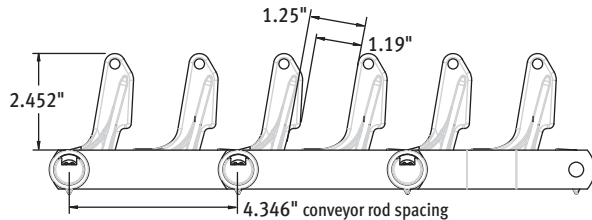

#### STANDARD

Standard Conveyor designed for General Ware including tableware (Plates/Bowls), most serving trays (lip height less than 1 1/4") as well as prep-ware (Hotel & Sheet Pans).

- Optional cross-rods every 4th row available for additional support of heavier ware (oversized ware/mixing bowls) as well as to promote warewashing drainage at optimal angle (hotel pans).

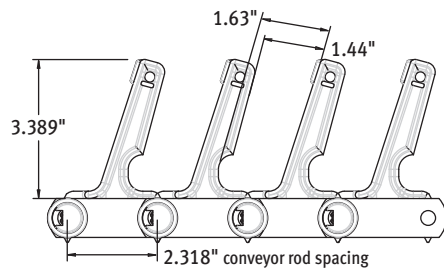

#### TYPE A

Optional Conveyor designed exclusively with our Healthcare segments in mind. In addition to accommodating General Ware, the Type A conveyor has a tighter conveyor rod spacing which provides increased conveyor density for added strength, as well as additional finger height and spacing to support most insulated dome bases and lids.

- Optional cross-rods every 4th row available for additional support of heavier ware (oversized ware/mixing bowls) as well as to promote warewashing drainage at optimal angle (hotel pans).

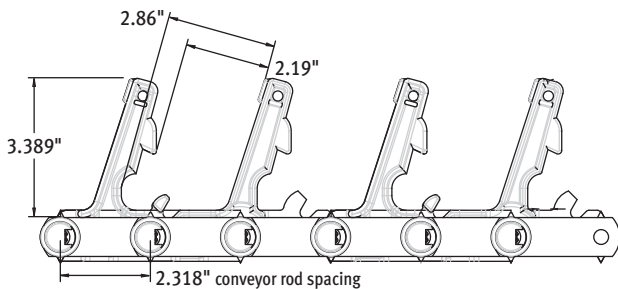

#### POSITION 1

Optional Conveyor designed for customers using insulated compartmentalized trays, as well as thicker insulated dome bases and lids. In addition to accommodating General Ware, the Position 1 conveyor provides even greater spacing between fingers, as well as a pronounced 3/8" "nose" to secure compartmentalized trays in place.

- Optional cross-rods every 4th row available for additional support of heavier ware (oversized ware/mixing bowls) as well as to promote warewashing drainage at optimal angle (hotel pans). Cross-rods can also be used to create stable support for some compartmentalized trays to orient upright through dishmachine.

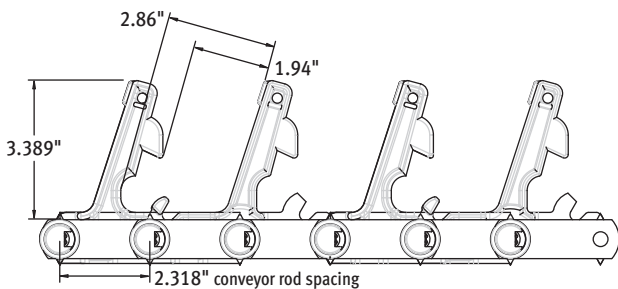

#### POSITION 2

Optional Conveyor designed for customers using insulated compartmentalized trays, as well as thicker insulated dome bases and lids. In addition to accommodating General Ware, the Position 2 conveyor provides additional spacing between fingers, as well as a pronounced 5/8" "nose" to secure compartment trays in place.

- Optional cross-rods every 4th row available for additional support of heavier ware (oversized ware/mixing bowls) as well as to promote warewashing drainage at optimal angle (hotel pans). Cross-rods also create stable support for compartmentalized trays to orient upright through dishmachine.

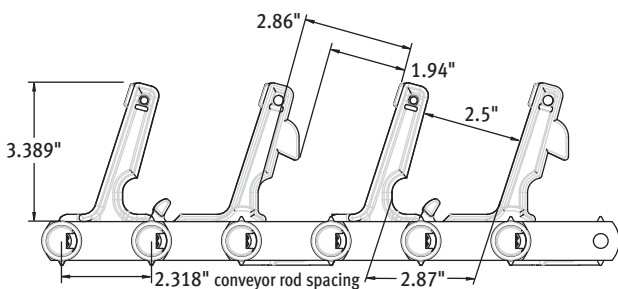

#### TIVOLI

Optional Conveyor designed exclusively with our Correctional segments in mind. In addition to accommodating General Ware, the Tivoli conveyor provides our widest spacing between fingers as well as a 5/8" "nose" to support the largest insulated compartmentalized trays, commonly used in correctional settings. The Tivoli conveyor comes standard with cross-rods every 3rd row for additional support of heavier ware (oversized ware/mixing bowls) as well as to promote warewashing drainage at optimal angle (hotel pans). Cross-rods also create stable support for compartmentalized trays to orient upright through dishmachine.



**DISHMACHINE LENGTH QUICK REFERENCE GUIDE**

Space Available	Model	Load Section	Center Section	Unload Section	Has Blower Dryer	*Total Length
		Load Platform, 3' Prewash, ASR (if equipped)	3' Wash Tank, 3' Rinse Tank (if equipped), 2' Dual Rinse	Control Box, Blower Dryer (if equipped), Unload Platform		
18'	Shorty	5' 10"	5'	6' 5"	NO	17' 5"
19'	Shorty	6' 10"	5'	6' 5"	NO	18' 5"
20'	Shorty	7' 10"	5'	6' 5"	NO	19' 5"
	Shorty	5' 10"	5'	8' 5"	YES	19' 5"
21'	Shorty	6' 10"	5'	8' 5"	YES	20' 4"
22'	Shorty	5' 10"	5'	10'	YES	21'
	Shorty	7' 10"	5'	8' 5"	YES	21' 4"
	Shorty	6' 10"	5'	10'	YES	21' 11"

\*Total length and section lengths are approximates. Refer to drawing for final length.

\*\*Automatic Soil Removal (ASR) does not add length to the machine.