

centerline
by **HOBART**



Centerline Models

CUH ML-130363
CUL ML-130364

ecoline
by **HOBART**



Ecoline Models

EUH ML-130377
EUL ML-130378

Commercial Dishwasher

Installation and Operation Manual

MACHINE INSTALLATION CHECKLIST

- Machine Serial Number _____
- Machine Contents Verified
 - Peg rack
 - Combination flat rack
 - Literature pack
 - Installation and operations manual
 - Programming card
 - Operations and error card
 - Operation and cleaning wall chart
 - Wiring diagram
 - Drain hose
 - Water supply hose
 - Small parts pack
 - Machine feet (4x)
 - Rubber tubing for machine feet (see section 5.5)
 - Band clamp for drain hose
 - Sanitizer chemical bottle level sensor (CUL only)
- Machine feet installed and leveled (see section 5.5)
- Electrical Hookup Completed (See section 5.6)
 - Voltage supplied to machine _____ V / 60 Hz / 1 Ph
 - Transformer connected for proper voltage (CUH & EUH only)
(see section 5.6.3)
- Water Hookup Completed (See section 5.7)
- Drain Hookup Completed (See section 5.8)
 - Proper building drain available (see section 5.8.2)
 - Drain hose attached to elbow fitting (see section 5.8.1)
 - Drain hose free of kinks
- Chemical Hookups Completed (See section 6)
 - Detergent and rinse aid hoses installed in correct containers
 - Sanitizer chemical level sensor installed (CUL only)
(See section 6.3)

TABLE OF CONTENTS

1 Notes on the documentation 7

 1.1 Application..... 7

 1.2 Layout of the documentation 7

 1.3 Representative convention 7

 1.3.1 Symbols used 7

 1.3.2 Representation in the text 8

2 Safety instructions and regulations 8

 2.1 Safety instructions and warning notices 8

 2.1.1 Hazard levels 8

 2.1.2 Layout of warning notices..... 8

 2.2 Basic safety instructions 8

 2.2.1 Product safety 8

 2.2.2 Personnel qualification 9

 2.2.3 Product-specific hazards 9

 2.3 Property damage 9

3 Product description 10

 3.1 Intended purpose..... 10

 3.2 Designation..... 10

 3.3 Technical specifications..... 10

4 Controls (See Operations section 6.7) 11

5 Installation..... 11

 5.1 Personnel qualification..... 11

 5.2 Special safety instructions 11

 5.3 Transporting to the installation location 12

 5.4 Removing the packaging 12

 5.5 Installing the machine 13

 5.6 Connecting to the power supply..... 13

 5.6.1 Electrical Data 14

 5.6.2 Electrical Connection Method..... 14

 5.6.3 Transformer connections (CUH Only)..... 16

 5.7 Connecting the water..... 17

 5.7.1 Water Requirements 17

5.7.2	Water Connection	17
5.8	Connecting the drain.....	18
5.8.1	Attaching drain hose to machine	19
5.8.2	Attaching drain hose to building drain	19
6	Chemical Supply Set Up	20
6.1	Personnel qualification.....	20
6.2	Preparing the chemical supply tubing.....	20
6.3	Preparing sanitizer chemical level sensor (CUL only).....	21
6.3.1	Attaching the sanitizer chemical level sensor to the sanitizer tubing.....	21
6.3.2	Connecting the sanitizer chemical level sensor control wire to the machine	21
6.4	Installing optional detergent and rinse aid chemical level sensors	21
6.4.1	Connecting the chemical level sensors to the detergent and rinse aid tubing.....	21
6.4.2	Connecting the detergent and rinse aid chemical level sensor control wires to the machine	21
6.5	Installing optional sanitizer chemical level sensor (EUL only)	22
6.5.1	Connecting the chemical level sensor to the sanitizer tubing	22
6.5.2	Connecting the sanitizer chemical level sensor control wire to the machine	22
6.6	Setup of external chemical bottles	22
6.6.1	Standard detergent and rinse aid suction tubes.....	22
6.6.2	Optional detergent and rinse aid chemical level sensors.....	22
6.6.3	Standard sanitizer suction tube (EUL only).....	23
6.6.4	Preparing the sanitizer (CUL machine only).....	23
6.6.5	Optional sanitizer chemical level sensor (EUL only).....	23
6.7	Filling chemical tubing (See Operator Menu for priming – section 8.1)	24
7	Operation	24
7.1	Personnel qualification.....	24
7.2	Special safety instructions	24
7.3	Notes for optimal washing result.....	24
7.4	Preparation for washing	25
7.4.1	Preparing the machine	25
7.4.2	Preparing the ware for washing.....	26
7.5	Washing.....	26
7.5.1	Extending wash time (CUH and CUL only)	27

- 7.6 Switch off machine..... 27
- 7.7 Daily cleaning or after each meal period..... 28
- 7.8 Weekly cleaning..... 28
- 7.9 Removing hard water deposits (Deliming) 29
 - 7.9.1 Delime notification (CUH and CUL only)..... 29
 - 7.9.2 Delime procedure..... 29
- 8 Settings 31
 - 8.1 Overview of operator menu 31
 - 8.2 Opening the operator menu..... 32
 - 8.3 Extended wash time (CUH and CUL only)..... 33
 - 8.4 Cycle count 34
 - 8.5 Detergent dispensing 35
 - 8.5.1 Setting detergent dispensing amount 35
 - 8.5.2 Priming detergent dispensing pump 35
 - 8.5.3 Inspecting detergent supply 37
 - 8.5.4 Detergent supply level sensor (Optional) 37
 - 8.6 Rinse aid dispensing 37
 - 8.6.1 Setting rinse aid dispensing amount 37
 - 8.6.2 Priming rinse aid dispensing pump 38
 - 8.6.3 Inspecting rinse aid supply..... 39
 - 8.6.4 Rinse aid supply level sensor (Optional)..... 40
 - 8.7 Sanitizer dispensing (CUL and EUL machine only) 40
 - 8.7.1 Setting sanitizer dispensing amount 40
 - 8.7.2 Priming sanitizer dispensing pump 41
 - 8.7.3 Inspecting sanitizer supply (CUL only)..... 43
 - 8.7.4 Inspecting sanitizer supply (EUL only) 43
 - 8.7.5 Sanitizer supply level sensor (Optional for EUL) 43
 - 8.8 Temperature display units..... 44
 - 8.9 Aux Channels 44
 - 8.10 Software Version / Machine Program..... 44
- 9 Display of errors and information 45
 - 9.1 Error 45
 - 9.2 Information..... 47

- 10 Troubleshooting guide 48
 - 10.1 Poor wash results 48
 - 10.2 Other faults 49
- 11 Maintenance 49
- 12 Disposal 49
- 13 Product disclaimer 49
- 14 Notes 50

1 NOTES ON THE DOCUMENTATION

1.1 Application

This document contains important information for the installation and startup of the machine by qualified personnel, as well as the information required for day-to-day operation by the operator.

- ▶ Keep the operating instructions and all referenced documents in a safe and accessible place.



This Installation and Operations manual is subject to change. For the most up to date manual visit www.CenterlineFoodEquipment.com/centerline-resources.

1.2 Layout of the documentation

Referenced documents are all instructions that describe the installation, operation, maintenance, and repair of the device, as well as additional instructions for all accessories used.

For the operator:





- Operating instructions

For the qualified technician (available online):

- Installation instructions
- Circuit diagram
- Spare Parts Catalog

1.3 Representative convention

1.3.1 Symbols used

Symbol	Meaning
	Warning of hazardous electrical voltage
	Beware of hazardous substances
	Beware of hazard area
	Useful additional information and tips

1.3.2 Representation in the text

Representation	Meaning
NOTE	Important information on machine operation, not a warning notice
▶	Step
↳	Outcome/result
–	Listing 1 st level
•	Listing 2 nd level

2 SAFETY INSTRUCTIONS AND REGULATIONS

2.1 Safety instructions and warning notices

- ▶ During machine operation, observe the general safety instructions and warning notices that precede each action.

2.1.1 Hazard levels

The hazard level is part of the safety instructions and is denoted by the signal word. Potential consequences are differentiated by the choice of signal word.

 WARNING	potentially hazardous situation: can cause serious physical injury
NOTICE	potentially harmful situation: can cause damage to the product or other objects

2.1.2 Layout of warning notices

Warning notices are depicted with warning symbols and signal word in the corresponding safety colors.

WARNING!

Nature and source of the hazard

Explanation on the nature and source of the hazard.

- ▶ Measures for averting the hazard
- ▶ Additional measures for averting the hazard, where applicable.

2.2 Basic safety instructions

2.2.1 Product safety

The machine conforms to state-of-the-art technology and the recognized safety regulations. Nonetheless, hazards may occur.

Operate the machine only if it is in good working order and in compliance with the operating instructions.

2.2.2 Personnel qualification

- ▶ Observe the regulations on occupational health and safety.
- ▶ Carefully read through the operation manual before use.

Activity	Qualification/training
Installation/Setup	Qualified electrician and plumber
Work on the electrical system	Qualified electrician
Maintenance, repair	Hobart Service, or by qualified service technician

2.2.3 Product-specific hazards

- ▶ Observe the instructions on the packaging for storage, lifting or transporting.

Avoid electric shock, risk of fire:

- ▶ Do not allow water to flow under live components.
 - Make sure the machine is correctly stored (see frost damage section 2.3).
 - Make sure that the machine does not overflow when being filled.
- ▶ Have the machine connected to the power supply by qualified personnel.
- ▶ Have all maintenance to the machine carried out by qualified personnel.

Avoid chemical burns, irritation of the skin, poisoning:

- ▶ Wear protective equipment (gloves, safety goggles, protective clothing) when handling chemicals.
- ▶ Use only suitable chemicals. Observe the manufacturer's instructions.
- ▶ Do not open the machine during operation, wait for the cycle to finish.
- ▶ For cleaning, wear protective equipment (gloves, safety goggles, protective clothing) when touching parts contaminated by detergent.

Avoid burns, scalds:

- ▶ Do not open the machine during operation, wait for the cycle to finish. Otherwise, hot water could spray out.

2.3 Property damage

Avoid frost damage:

Temperatures below 32°F (0°C) lead to functional damage.

- ▶ Before storing below 32°F (0°C), empty residual water in hoses, tank and booster.
- ▶ Prior to restart, store the machine at room temperature (min. 60°F) for 24 hours.

3 PRODUCT DESCRIPTION

3.1 Intended purpose

The machine is an item of technical equipment intended solely for commercial dishwashing.

The machine is designed solely for cleaning ware (porcelain, glass, ceramic, temperature-resistant plastics, stainless steel or similar) from the food industry.

3.2 Designation

The rating label is located on the right side of the machine. If you have any questions regarding service and parts, use the serial number in all communications.

3.3 Technical specifications

Model	CUH	EUH	CUL	EUL
Dimensions (H x W x D)	32.375 x 22.688 x 24.000 in (822.3 x 576.3 x 609.6 mm)		32.375 x 22.688 x 24.000 in (822.3 x 576.3 x 609.6 mm)	
Water consumption per cycle	0.84 gal (3.2 L)	0.91 gal (3.4 L)	0.84 gal (3.2 L)	0.92 gal (3.5 L)
Hot water connection	110°F (43°C) min. 140°F (60°C) max.		120°F (49°C) min. 140°F (60°C) max.	
Voltage	208-240V / 60Hz / 1∅		120V / 60Hz / 1∅	
Total connected load	24.2 A / 27.5 A		17.5 A	
Fuse/breaker protection	30 A / 30 A		20 A	
Tank capacity	5.3 gal (20.0 L)		5.3 gal (20.0 L)	
Loading height	15.375 in (390.5 mm)		15.375 in (390.5 mm)	
Machine weight	120 lbs. (55 kg)		120 lbs. (55 kg)	

4 CONTROLS (SEE OPERATIONS SECTION 6.7)

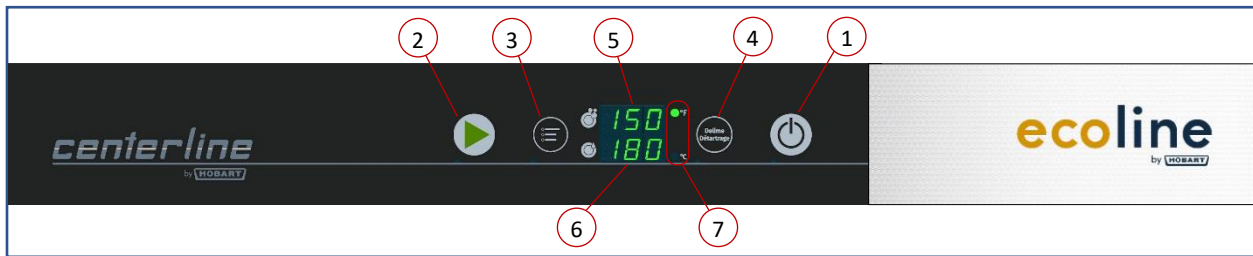

①	Power/Drain Button	Pressing this button switches the machine on, fills and heats the wash tank. Pressing and holding (3 seconds) activates self-cleaning cycle, drains machine, and then switches the machine off automatically.
②	Start Button	Pressing this button starts the wash cycle. <i>CUH & CUL Only:</i> If pressed a 2 nd time within 10 seconds of the first press, the extended wash cycle is activated.
③	Menu Button	Pressing this button enters the configuration menu.
④	Delime Button	Pressing and holding this button (3 seconds) initiates the deliming cycle.
⑤	Temperature Display, Wash Tank	Displays wash tank temperature while machine is idle or in a wash cycle.
⑥	Temperature Display, Rinse	Displays rinse temperature only during rinse cycle.
⑦	Temperature Units	LED lights for °F or °C

5 INSTALLATION

5.1 Personnel qualification

Installation must only be carried out by qualified personnel.

5.2 Special safety instructions

WARNING!

Risk of electric shock, fire hazard



Water (frost damage, machine overflow) flowing over live components can cause injury from electric shock or fire.

- ▶ Do not allow water to flow under live components.
- ▶ Make sure the machine is correctly stored.
- ▶ Make sure that the machine does not overflow when being filled.

NOTICE!

Frost damage

Temperatures below 32°F (0°C) during transport/storage cause function impairments.

- ▶ Prior to installation, store machine at room temperature (min. 60°F) for 24 hours.

5.3 Transporting to the installation location

- ▶ Where possible transport packed on the pallet.

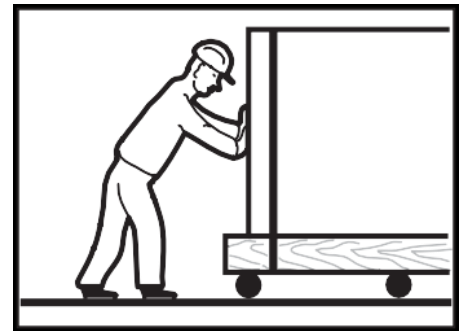

- ▶ Use suitable transport means (forklift or hand truck, etc.).

5.4 Removing the packaging

- ▶ Remove packaging materials and accessories from the machine.

Packaged in machine
<ul style="list-style-type: none"> • Peg rack • Combination flat rack • Literature pack <ul style="list-style-type: none"> ↳ Installation and operations manual ↳ Programming card ↳ Operations and error card ↳ Operation and cleaning wall chart ↳ Wiring diagram • Drain hose • Water supply hose • Small parts pack <ul style="list-style-type: none"> ↳ Machine feet (4x) ↳ Rubber tubing for machine feet ↳ Band clamp for drain hose • Sanitizer bottle level sensor (CUL Only)

- ▶ Immediately after unpacking the dishwasher, check for possible shipping damage. If this machine is found to be damaged, save packaging materials and contact the carrier within 5 days of delivery.

5.5 Installing the machine

Prior to installation, verify that the electrical supply agrees with the specifications on the machine data label, which is located on the lower, right side of the machine.

Wall clearance is not required.

- ▶ Install the provided feet in each of the bottom corners of the machine.
- ▶ The machine must be level to operate properly. Place the dishwasher in its operating location. Level the machine before any connections are made. Using a carpenter's level placed diagonally on the rack tracks, level the machine front to back and side to side by threading the adjustable feet in or out.
- ▶ After leveling the machine, cover the exposed threads of the adjustable feet with the supplied rubber tubing.
 - Measure exposed length of threads on adjustable foot ("X")
 - Cut required length of rubber tubing, slit one side of cut piece and install over threaded portion of adjustable foot.

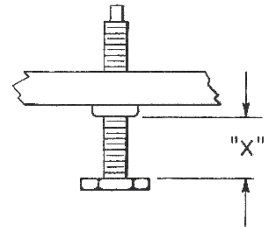

NOTICE!

Property damage

NOTE: Steam generated from normal operation may escape from the door.

- ▶ Wood, laminates, veneers, etc. are unsuitable materials for use in areas exposed to dishwasher steam and detergents. Stainless steel or other moisture-resistant shields are recommended for surfaces adjacent to machine sides and top.

5.6 Connecting to the power supply

⚠ WARNING!

Risk of electric shock

Electrical and grounding connections must comply with the applicable portions of the National Electrical Code and/or other local electrical codes.

- ▶ Disconnect the electrical power to the machine and follow lockout/tagout procedures.

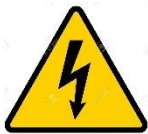

5.6.1 Electrical Data

Complied in accordance with the National Electrical Code NFPA-70, latest addition.

NOTICE!

Supply connections

- ▶ For supply connections, use copper wire only rated at 90°C minimum.
- ▶ The dish machine is not provided with internal GFCI protection.

Model	Volts/Hertz/Phase	Rated Ampacity	Minimum Supply Circuit Conductor Ampacity	Maximum Protective Device Ampacity
CUH EUH	208/60/1	24.2	30	30
	240/60/1	27.5	30	30
CUL EUL	120/60/1	17.5	20	20

Refer to the data label on the lower, right side of the machine for proper selection.

5.6.2 Electrical Connection Method

- ▶ Remove the lower front panel by removing the two screws at the bottom of the panel.

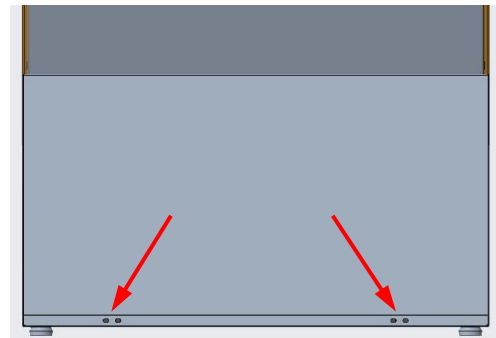

- ▶ Remove control board bracket and chemical pump bracket nuts.

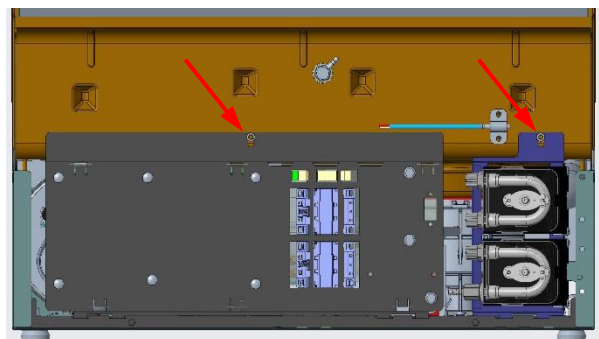

- ▶ Lower control board bracket and chemical pump bracket to allow access to terminal block 1TB.

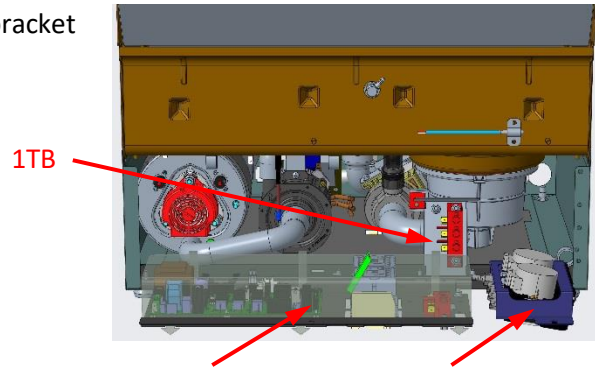

- ▶ A hole for 1" trade size conduit is supplied at the lower left in the back of the machine.

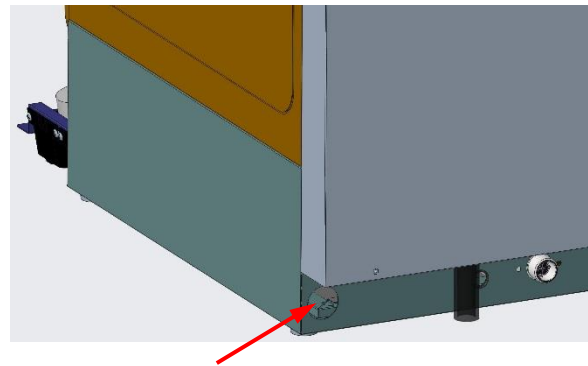

- ▶ Install 1" trade size conduit or cable and fitting. Leave at least four feet of electrical line between wall connection and machine. This allows machine to be pulled away from wall for cleaning and/or servicing.

- ▶ Make electrical connections according to wiring diagram supplied with the machine and secure wires to the machine service connection. Keep excess wire in the base of the unit to a minimum. A cable support is supplied to facilitate wire routing.

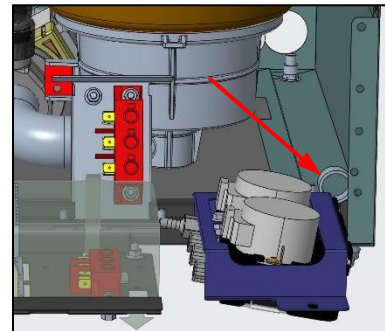

NOTICE!

208V or 240V electrical connections (CUH and EUH Only)

The 208V or 240V electrical connection for the CUH machine requires two hot wires and a ground. There is no current carrying neutral used.

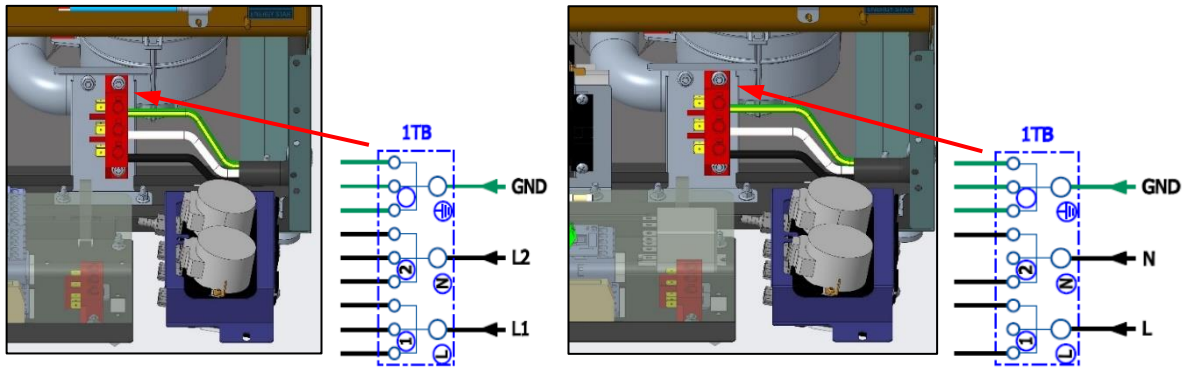

CUH & EUH (208-240V/60Hz/1Ph)

CUL & EUL (120V/60Hz/1Ph)

5.6.3 Transformer connections (CUH Only)

NOTICE!

Transformer connections (CUH and EUH Only)

For the CUH and EUH machines a control transformer is used to step the 208V or 240V incoming power to 120V for the control circuitry and drain pump. The transformer is factory-preset to 240V.

- For 208V incoming power, relocate the 1T-H wire on the transformer from the 240V terminal to the 208V terminal (See below for correct setup) – Refer to wiring diagram supplied with machine.

Note: Access transformer by tipping machine up and removing bottom panel.

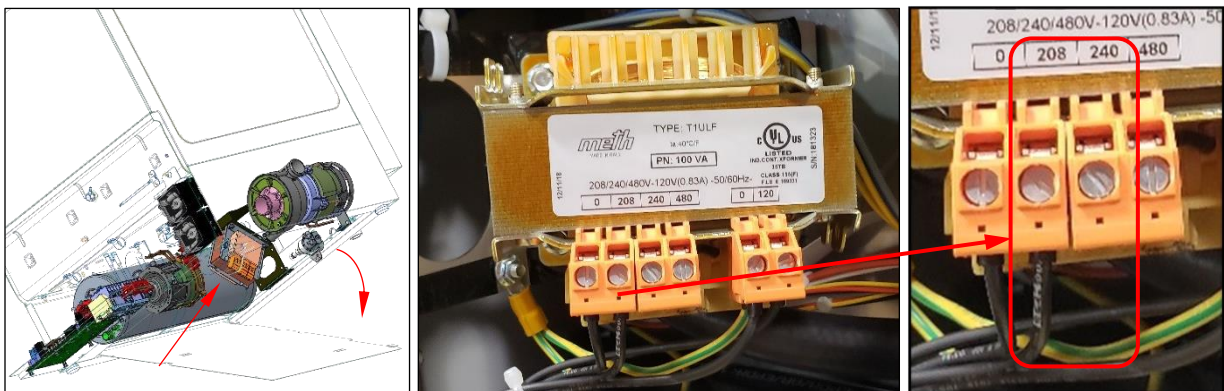

An incorrectly connected transformer can lead to machine draining issues.

5.7 Connecting the water

NOTE: The machine must be operated with potable water.

5.7.1 Water Requirements

Proper water quality can improve ware washing performance by reducing spotting, enhancing effectiveness of labor and extending equipment life. Water conditions vary from one location to another. The recommended proper water treatment for effective and efficient use of this equipment will also vary depending on the local water conditions. Ask your municipal water supplier for details about your local water conditions prior to installation.

Recommended water hardness is 3 grains of hardness per gallon or less. Higher hardness may cause excessive formation of lime scale. Water hardness above 3 grains per gallon requires water treatment. Water treatment has been shown to reduce costs associated with machine cleaning, reduce deliming of the dishwasher, and reduce detergent usage in the dishwasher.

NOTICE!

Water quality

High iron levels in the water supply can cause staining and may require an iron filter. High chloride levels in the water supply can cause pitting and may require a chloride removal system. Contact Hobart Service or your local water treatment professional for proper water treatment.

Sediment may require a particulate filter. Dissolved solids may require water treatment such as a water softener, reverse osmosis system, etc. Contact Hobart Service or your local water treatment professional for proper water treatment.

5.7.2 Water Connection

A water hammer arrestor (meeting ASSE-1010 Standard or equivalent) should be installed (supplied by others) in the common water supply line at the service connection.

The plumber connecting this machine is responsible for making certain that water lines are THOROUGHLY FLUSHED OUT BEFORE connecting to the dishwasher. This "flush-out" is necessary to remove all foreign matter, such as chips (resulting from cutting or threading of pipes), pipe joint compound from the lines; or, if soldered fittings are used, bits of solder or cuttings from the tubing. Debris, if not removed, may lodge in the dishwasher's plumbing components and render them inoperative. Solenoid valves fouled by foreign matter and any expenses resulting from this fouling are NOT the responsibility of the manufacturer and associated repair costs are not covered under warranty.

A manual shutoff valve (not supplied) should be installed upstream of the fill hose to accommodate servicing the machine. It is recommended that a line strainer (80 mesh) (not supplied) be installed in the supply line between the manual shutoff valve (not supplied) and the connection point on the machine. Make plumbing connections with ½" minimum copper piping OD (¾" recommended), with a ¾" male garden hose fitting (not supplied).

Connect to hot water

A water supply hose is provided.

Temperature:

- CUH and EUH: 110°F (43°C) minimum
- CUL and EUL: 120°F (49°C) minimum

Water hardness: max. 3 grains

Flowing pressure:

- 15 psi – 65 psi (1 bar – 4.5 bar)
- > 65 psi (4.5 bar): Provide pressure regulating valve (not supplied)
- < 15 psi (1 bar): Improper machine operation may result

NOTICE!

Pressure regulating valve

- ▶ The water pressure regulator must have a relief bypass. Failure to use the proper type of pressure regulator may result in damage to the unit.

- ▶ Attach one end of the of the water supply hose ($\frac{3}{4}$ " garden hose thread) to the machine fill valve located on the lower, back of the machine.

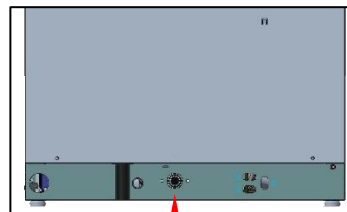

- ▶ Connect the other end of the water supply hose "A" ($\frac{3}{4}$ " garden hose thread) to the building shut off valve.
- ▶ Do not kink or cut the water supply hose.
- ▶ Any required extension must be made using a suitable pressure hose.

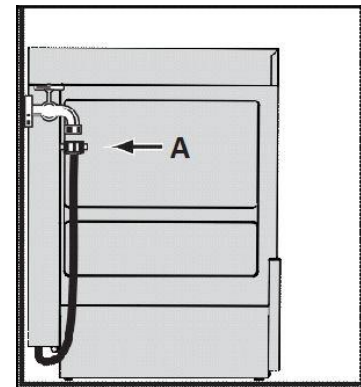

5.8 Connecting the drain

A drain hose, 19mm inside diameter, is provided.

⚠ WARNING!

Plumbing connections

Plumbing connections must comply with applicable sanitary, safety, and plumbing codes.

5.8.1 Attaching drain hose to machine

Attaching drain hose to machine

- ▶ Remove 4 screws holding rear cover panel to machine.

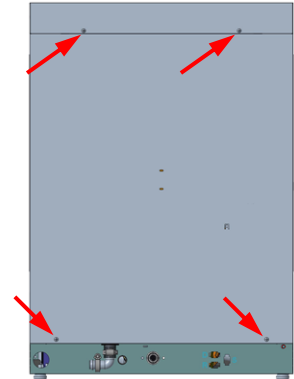

- ▶ Attach the supplied drain hose to the drain elbow with the supplied hose clamp.

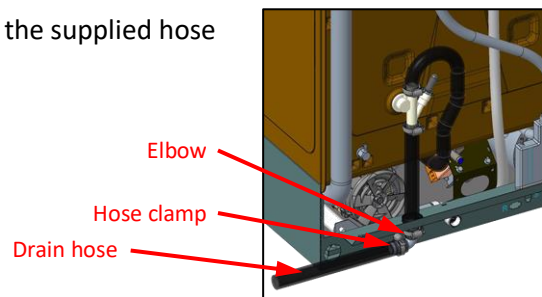

- ▶ Turn elbow to direction needed for drain hose
 - Loosen hose clamp at either the anti-siphon valve or elbow
 - Turn elbow
 - Retighten hose clamps

- ▶ Replace the rear cover panel

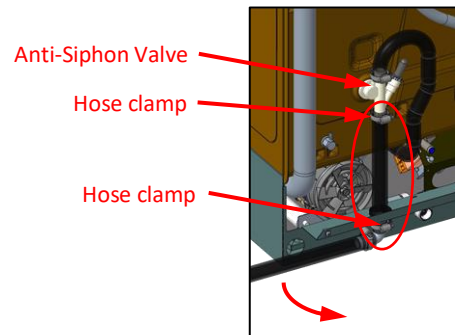

5.8.2 Attaching drain hose to building drain

Attaching drain hose to building drain

Note that:

- The connection between machine and site drain must not exceed a maximum height of 34" above finished floor.
- Drain must have a minimum flow capacity of 5 gallons per minute.
- Leave at least four feet of drain hose between wall connection and machine. This allows machine to be pulled away from wall for cleaning and/or servicing.
- A pumped drain air gap kit is available using accessory code PUMPDRN-AIRGAP or service kit part number 00-562492. Refer to installation instructions included with kit.
- Use care not to kink the drain hose.

NOTICE!

Drain connection

An improper drain connection or a kinked hose could result in reduced machine performance and errors. An air gap connection is the preferred connection method.

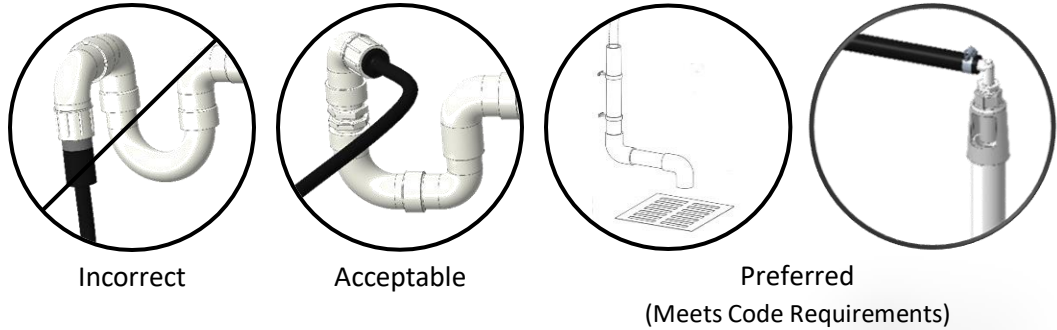

6 CHEMICAL SUPPLY SET UP

6.1 Personnel qualification

Set up must only be carried out by qualified personnel (see section 2.2.2).

6.2 Preparing the chemical supply tubing

Preparing the chemical supply tubing:

- ▶ Locate the chemical tubing attached to the rear of the machine.
- ▶ Remove the nylon quick-tie holding the chemical tubing to the rear of the machine.

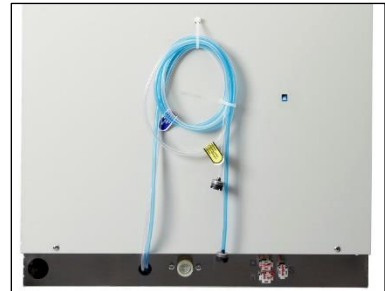

- ▶ Separate the tubing corresponding to the chemical labels:
 - ↳ The clear tubing with the attached filter and yellow detergent label corresponds to Detergent
 - ↳ The blue tubing with the attached filter and blue rinse agent label corresponds to Rinse Aid
 - ↳ The clear tubing with either the cut end (CUL only) or the attached filter (EUL only) without a label corresponds to Sanitizer



6.3 Preparing sanitizer chemical level sensor (CUL only)

6.3.1 Attaching the sanitizer chemical level sensor to the sanitizer tubing

- ▶ Locate the sanitizer chemical level sensor that was packaged with the CUL machine.

- ↳ Note: The sanitizer chemical level sensor will have a blue stopper and blue sensor wire.



- ▶ Push the clear sanitizer tubing all the way onto the stem end of the sanitizer chemical level sensor.

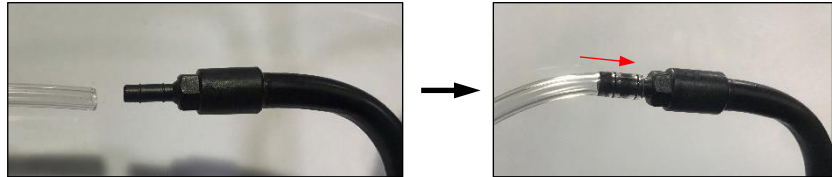

6.3.2 Connecting the sanitizer chemical level sensor control wire to the machine

- ▶ Locate the chemical level sensor electrical connectors plugs on the back of the machine.

- ↳ **D** = Detergent sensor electrical connection
- ↳ **R** = Rinse Aid sensor electrical connection
- ↳ **S** = Sanitizer sensor electrical connection

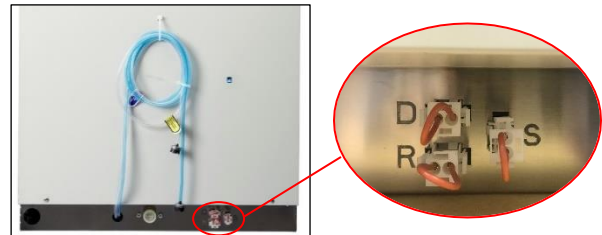

- ▶ Remove the electrical jumper plug from the **S** sanitizer sensor connection



- ▶ Attach the electrical plug from the sanitizer chemical level sensor

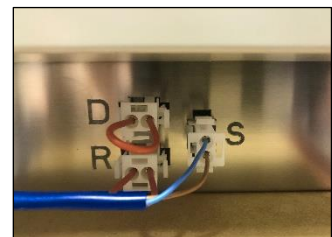

6.4 Installing optional detergent and rinse aid chemical level sensors

6.4.1 Connecting the chemical level sensors to the detergent and rinse aid tubing

Refer to instructions supplied with the chemical level sensor accessory kit.

6.4.2 Connecting the detergent and rinse aid chemical level sensor control wires to the machine

Refer to instructions supplied with the chemical level sensor accessory kit.

6.5 Installing optional sanitizer chemical level sensor (EUL only)

6.5.1 Connecting the chemical level sensor to the sanitizer tubing

Refer to instructions supplied with the chemical level sensor accessory kit.

6.5.2 Connecting the sanitizer chemical level sensor control wire to the machine

Refer to instructions supplied with the chemical level sensor accessory kit.

6.6 Setup of external chemical bottles

NOTE: The suction height of the detergent, rinse aid, and sanitizer pumps: max. 5 ft

6.6.1 Standard detergent and rinse aid suction tubes

Standard suction tubes

- ▶ Place clear suction tubing marked for detergent at the bottom of the external detergent bottle/bucket.
- ▶ Place blue suction tubing marked for rinse aid at the bottom of the external rinse aid bottle/bucket.

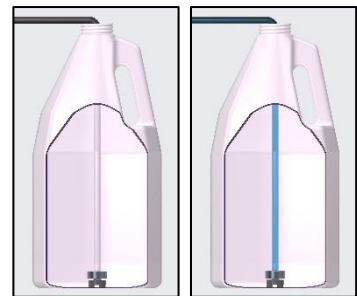

6.6.2 Optional detergent and rinse aid chemical level sensors

Optional detergent and rinse aid chemical level sensors

If the machine has installed the optional detergent and rinse aid chemical level sensing wands (see section 6.4) then:

- ▶ Place the chemical level sensing wand into the external bottle or bucket so that the float end of the sensor touches the bottom of the container.
 - ↳ The detergent chemical level sensor will have clear tubing attached to it.
 - ↳ The rinse aid chemical level sensor will have blue tubing attached to it.
- ▶ Adjust the stopper on the chemical level sensing wands to seal to the bottle or bucket.
- ▶ Make sure the chemical level sensing wand is correctly inserted into the container with the float sensor at bottom of the container.

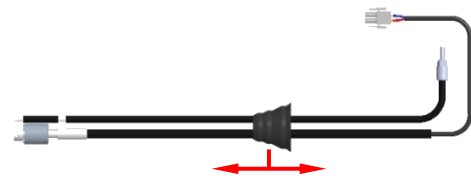
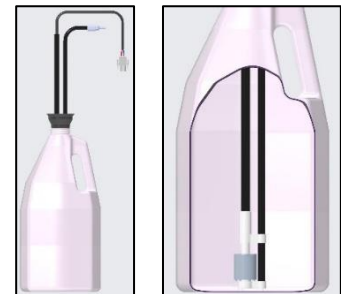

6.6.3 Standard sanitizer suction tube (EUL only)

Standard suction tube

- ▶ Place clear suction tubing with no label at the bottom of the external sanitizer bottle/bucket.

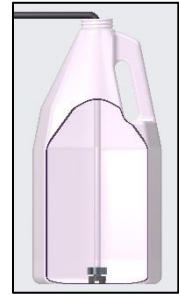

6.6.4 Preparing the sanitizer (CUL machine only)

Preparing the sanitizer

Suction height of sanitizer pump: max. 5 ft

- ▶ Place the sanitizer chemical level sensing wand into the external bottle or bucket so that the float end of the sensor touches the bottom of the container.
 - ↳ The wand will have a blue stopper and electrical wire.

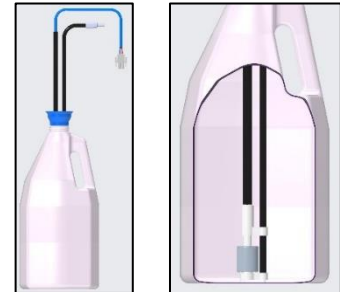

- ▶ Adjust the stopper on the sanitizer chemical level sensing wand to seal to the bottle or bucket.
- ▶ Make sure the sanitizer chemical level sensing wand is correctly inserted into the container with the float sensor at the bottom of the container.

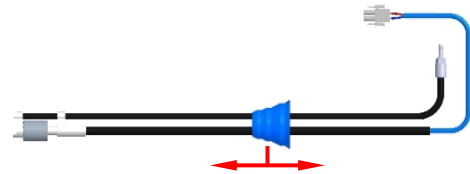

6.6.5 Optional sanitizer chemical level sensor (EUL only)

Optional sanitizer chemical level sensor

If the machine has installed the optional sanitizer chemical level sensing wand (see section 6.5) then:

- ▶ Place the sanitizer chemical level sensing wand into the external bottle or bucket so that the float end of the sensor touches the bottom of the container.
 - ↳ The wand will have a blue stopper and electrical wire.

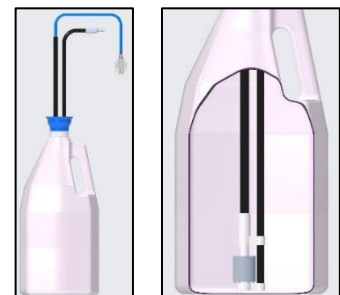

- ▶ Adjust the stopper on the sanitizer chemical level sensing wands to seal to the bottle or bucket.
- ▶ Make sure the sanitizer chemical level sensing wand is correctly inserted into the container with the float sensor at bottom of the container.

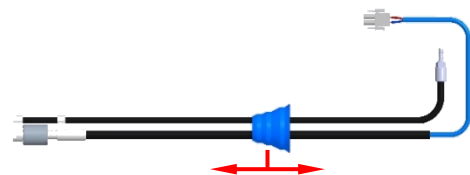

6.7 Filling chemical tubing (See Operator Menu for priming – section 8.1)

⚠ WARNING!



Chemical burns, irritation of the skin

Filling the chemical tubing with detergent, rinse aid or sanitizer for the first time incorrectly can cause serious injury.

- ▶ Wear protective equipment (gloves, safety goggles, protective clothing) when handling chemicals.
- ▶ Observe the manufacturer’s application and safety instructions.

7 OPERATION

7.1 Personnel qualification

The machine must be operated by qualified personnel.

7.2 Special safety instructions

⚠ WARNING!



Chemical burns, irritation of the skin, scalding

If the door is opened during operation, wash water can spray out and cause injury.

- ▶ Do not open the door during operation, wait for the cycle to finish.

7.3 Notes for optimal washing result

The rinse result is significantly affected by the water quality. If the mineral content is high, the minerals dissolved become visible on the glasses in the form of spots and streaks during the drying process.



A HOBART trained service technician can determine the water's mineral content by measuring the grains. Recommended water hardness is 3 grains of hardness per gallon or less. Higher hardness may cause excessive formation of lime scale. Water hardness above 3 grains per gallon requires water treatment.

If you have any questions, please contact your authorized HOBART service partner.

7.4 Preparation for washing

7.4.1 Preparing the machine

- ▶ Check correct position of pump strainer and tank strainers and proper installation of upper and lower wash/rinse arms.



- ▶ Open building water shut-off valve.
- ▶ Turn on main switch, breaker, or insert the plug.
- ▶ Check level of detergent and rinse aid in containers (See sections 8.5.3 and 8.6.3).

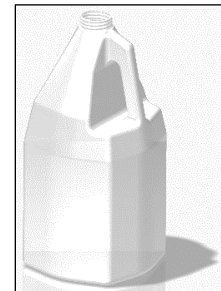

- ▶ For CUL machine, check level of sanitizer in container (See section 8.7.3).
- ▶ For EUL machine, check that there is sanitizer present (See section 8.7.4).

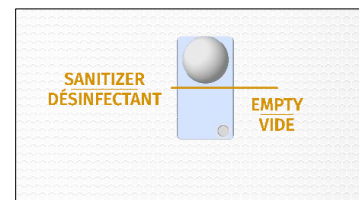

- ▶ Close door.
- ▶ Press the Power/Drain button.



- ↳ During the filling and heating processes, the Power/Drain button LED flashes. This process can take several minutes.
- ↳ As soon as the LED is permanently lit on both the Power/Drain button LED and the Start button LED, the machine is ready for operation.

7.4.2 Preparing the ware for washing

- ▶ Remove heavy food residue.

- ▶ Load ware into rack.

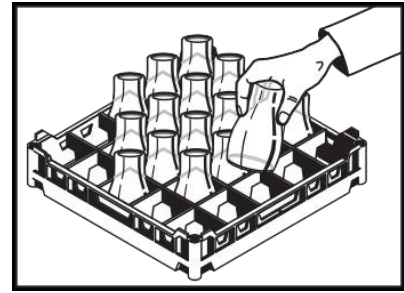

- ▶ Rinse off ware.

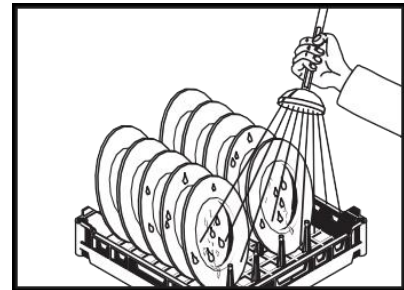

7.5 Washing

- ▶ Open door.

- ▶ Slide rack into the machine and close the door.

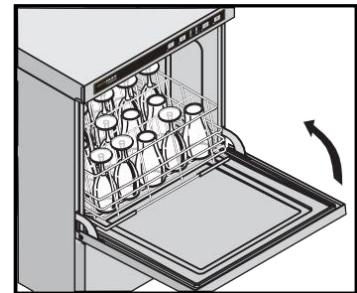

- ▶ Press the Start button.



- ↳ While the washing cycle is running, the Start button LED flashes. As soon as the Start button LED lights up permanently, the rinsing process is complete, and cycle ends.
- ↳ The wash temperature is shown in the upper display for the entire cycle.
- ↳ The rinse temperature is shown on the lower display only during the rinsing portion of the cycle.

- ▶ Open the door and remove the rack.
- ▶ Allow the ware enough time to dry.

7.5.1 Extending wash time (CUH and CUL only)

For heavier soiled ware, the wash cycle time can be extended by up to 4 minutes. (See section 8.3)

- ▶ To extend the washing time, start a normal 2-minute washing cycle by pressing the Start button and within the first 10 seconds of the cycle starting, press the Start button a 2nd time.



- ↳ While the extended washing cycle is running, both the Start button LED and the Menu button LED flashes. As soon as the Start button LED lights up permanently, the rinsing process is complete, and cycle ends.

7.6 Switch off machine

- ▶ Press and hold the Power/Drain button (3 seconds).



- ↳ During draining, the display will show “drA in”.
- ↳ During draining, the Power/Drain button LED flashes.



During draining, the machine interior is rinsed automatically, and the tank and booster are emptied.

- ↳ At the end of the draining cycle, the machine switches off automatically.

When the machine has switched off:

- ▶ Remove any heavy food residues.
- ▶ Turn off main switch, breaker, or remove the plug.
- ▶ Close building water shut-off valve.

7.7 Daily cleaning or after each meal period

NOTICE!

Property damage

The use of unsuitable agents can cause corrosion damage.

- ▶ Do not use any bleach, acids, or metal-containing additives to clean the machine.
- ▶ Do not use metal brushes.

- ▶ Open the door, remove tank, and pump strainers. Rinse under running water. Make sure that food debris does not enter pump intake when the pump strainer is removed.

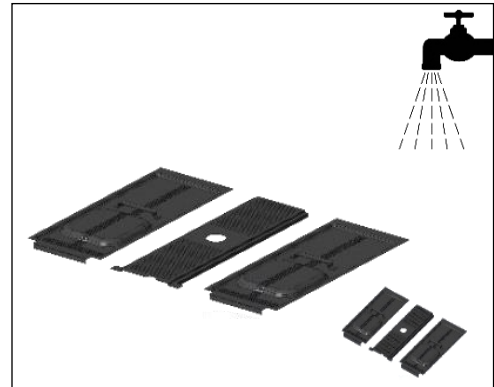

- ▶ Clean machine interior.

- ▶ Replace pump and tank strainers.

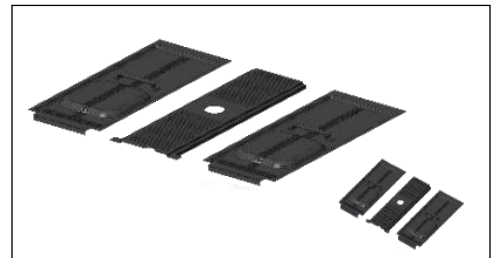

- ▶ Allow time for interior to dry.

7.8 Weekly cleaning

- ▶ Depress two buttons on side of lower wash/rinse arm.

- ▶ Remove and clean wash/rinse arm.

- ▶ Repeat for upper arm.

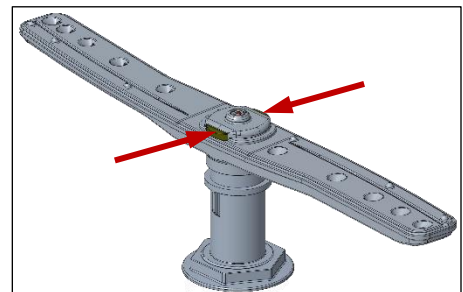

- ▶ Replace all parts.

7.9 Removing hard water deposits (Deliming)

The dishwasher should be delimed on a regular basis as required. How often depends on the mineral content of the water. Deliming should be done when you can see clear signs of lime deposits (a white chalky substance) on the inside walls, on the wash and rinse arms or tank heater. Inspect the machine interior for lime deposits. When deliming is necessary, a deliming agent (such as Lime-A-Way® or LSR®) should be used for best results.

WARNING!

Chemical mixing



Deliming solution must not come in contact with bleach or rinse solution containing bleach. Mixing may cause hazardous gas to form. This entire procedure must be followed step-by-step for safe and satisfactory results.

7.9.1 Delime notification (CUH and CUL only)

The CUH and CUL machines are equipped with an automatic delime cycle reminder. It is recommended that deliming be done when the Delime button LED is flashing. Deliming can also be initiated at any other time if deemed necessary.

7.9.2 Delime procedure

- ▶ Machine must be on and at a ready state (Power/Drain button LED lit permanently).
- ▶ Open the door, remove tank strainers. Rinse under running water.

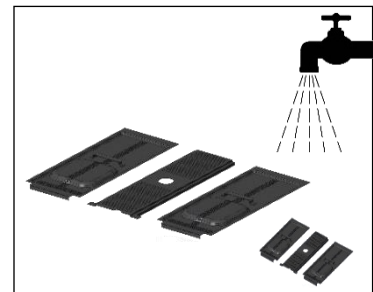

- ▶ Replace tank strainers.



- ▶ Close door.

- ▶ Press and hold the Delime button (minimum 3 seconds).



- ↳ The upper display will show “SdL” to show that the delime cycle has started.
- ↳ The machine will enter a drain and rinse phase. During this phase the delime button LED will be lit continuously.



The deliming cycle is extensive and can take 30 minutes or more to complete.

- ↳ When ready to add deliming agent, the upper display will show “Add”. The delime button LED will flash.



- ▶ Open the door.
- ▶ Add the correct amount of deliming agent to the tank according to the manufacturer’s instructions (Refer to section 3.3 for tank volume).

⚠ WARNING!

Chemical burns, irritation of the skin.

The use of unsuitable chemicals can cause injury.



- ▶ Use only commercial deliming agent.
- ▶ Observe the manufacturer’s application and safety instructions.

- ▶ Close the door.
 - ↳ The delimiting process will continue. The delime button LED will be lit continuously.
 - ↳ The upper display will show “dL”.



- ↳ When the delimiting phase completes, the machine will enter a drain and rinse phase. During this phase the delime button LED will be lit continuously.
- ↳ After the delimiting process is completed, the machine will drain and shut down.

8 SETTINGS

8.1 Overview of operator menu

CUH / EUH (High Temperature Sanitizing Machine)

Item	Menu Function	Function
00	Extended Wash Time (CUH only)	Sets extended wash time
01	Cycle Count (Rinse)	Displays number of wash/rinse cycles completed
02	Detergent Setpoint	Setting of detergent concentration (g/l)
03	Detergent Pump Prime	Primes detergent pump
04	Rinse Aid Setpoint	Setting of rinse aid concentration (g/l)
05	Rinse Aid Pump Prime	Primes rinse aid pump
08	Temperature Units	Sets temperature display to °F or °C
09	Aux Channel	Internal functions
10	Aux Channel	Internal functions
11	Aux Channel	Internal functions
12	Software	Software version / Machine type

CUL / EUL (Chemical Sanitizing Machine)

Item	Menu Function	Function
00	Extended Wash Time <i>(CUL only)</i>	Sets extended wash time
01	Cycle Count (Rinse)	Displays number of wash/rinse cycles completed
02	Detergent Setpoint	Setting of detergent concentration (g/l)
03	Detergent Pump Prime	Primes detergent pump
04	Rinse Aid Setpoint	Setting of rinse aid concentration (g/l)
05	Rinse Aid Pump Prime	Primes rinse aid pump
06	Sanitizer Setpoint	Setting of sanitizer concentration (ppm)
07	Sanitizer Pump Prime	Primes sanitizer pump
08	Temperature Units	Sets temperature display to °F or °C
09	Aux Channel	Internal functions
10	Aux Channel	Internal functions
11	Aux Channel	Internal functions
12	Software	Software version / Machine type

8.2 Opening the operator menu

Note: Machine must be in ready (idle) state.

- ▶ Press the Menu button to access operator program settings.



↳ The menu opens, and the Menu button LED illuminates.

↳ The upper display will show the first item “00”.

- ▶ To scroll from one item to the next, press the Wash button. After the last item, the sequence will return to the first item.

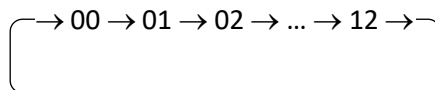

- ▶ To save and exit the operator menu at any time, open the machine door and then close it.

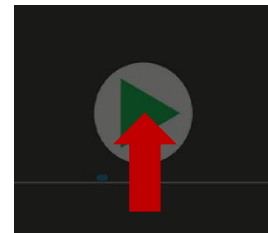

8.3 Extended wash time (CUH and CUL only)

- ▶ Top display shows “00”



- ▶ Press the Menu button to edit settings

↳ Bottom display shows current extended wash setting (in minutes): (default = 4)



Extended Wash setting can be set from 3 minutes to 6 minutes total wash time in 1-minute intervals.

- ▶ To increase time, press the Menu button
- ▶ To decrease time, press the Delime button



To save and exit the edit mode, either:

- ▶ Press Start Button to move to next item

– Or –

- ▶ Open and close door (Will also exit operator menu)

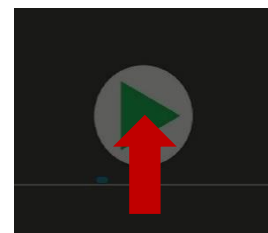

8.4 Cycle count

- ▶ Top display shows “01”



- ▶ Press the Menu button to display the cycle count

↳ Bottom display shows first 3 digits of the 6-digit cycle count number (ex. 012345)



- ▶ Press the Menu button a 2nd time

↳ Bottom display shows last 3 digits of the 6-digit cycle count number (ex. 012345)



To exit the cycle count menu, either:

- ▶ Press Start Button to move to next item

– Or –

- ▶ Open and close door (Will also exit operator menu)

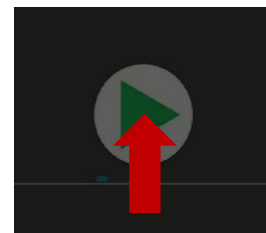

8.5 Detergent dispensing

8.5.1 Setting detergent dispensing amount

- ▶ Top display shows “02”

↳ Bottom display shows current detergent dispensing settings in g/L: (default = 2.0 g/L)

Note: 1.0 g/L ≈ 0.1 % concentration (by vol.)



Detergent dispensing amount can be set from 0.0 g/L to 9.5 g/L in 0.5 g/L increments.

- ▶ To increase dosage by 0.5 g/L, press the Menu button
- ▶ To decrease dosage by 0.5 g/L, press the Delime button



To save and exit, either:

- ▶ Press Start Button to move to next item

– Or –

- ▶ Open and close door (Will also exit operator menu)

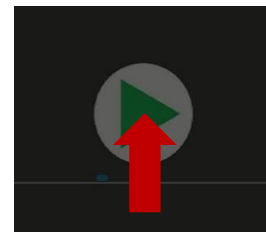

8.5.2 Priming detergent dispensing pump

- ▶ Top display shows “03”

↳ Bottom display shows “0”



- ▶ Press the Menu button to change bottom display value to “1”



- ▶ Press delime button to begin detergent dispensing pump priming
 - ↳ The detergent dispensing pump will activate for 60 seconds
 - ↳ The decimal point in the bottom display will flash while the dispensing pump is on

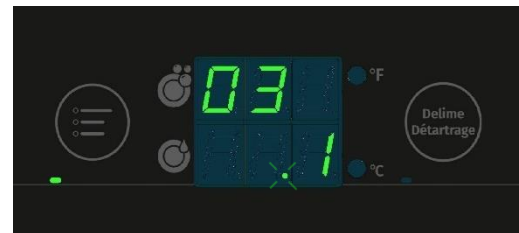

- ▶ Verify the detergent is moving from the detergent bottle or container to the machine through the tubing and that there are no air bubbles in the tubing.



- ↳ Note: The priming process might need to be repeated at least 2 times to fully prime the machine.

To exit the priming menu, either:

- ▶ Press Start Button to move to next item

– Or –

- ▶ Open and close door (Will also exit operator menu and stop priming)

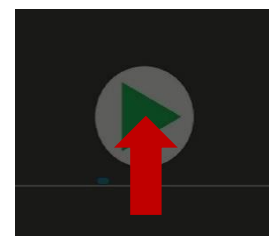

8.5.3 Inspecting detergent supply

- ▶ Inspect detergent container for chemical present.
- ▶ Verify that the supply tube is correctly inserted with the suction filter at the bottom of the container.
 - ↳ If air bubbles (large gaps) are present in detergent line – prime (refer to 8.5.2)

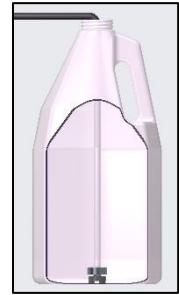

8.5.4 Detergent supply level sensor (Optional)

- ▶ Inspect detergent container for chemical present.
- ▶ Make sure the bottle level sensor is correctly inserted into container with float sensor at bottom of container.
 - ↳ If air bubbles (large gaps) are present in detergent line – prime (refer to 8.5.2)



8.6 Rinse aid dispensing

8.6.1 Setting rinse aid dispensing amount

- ▶ Top display shows “04”
 - ↳ Bottom display shows current rinse aid dispensing settings in g/L: (default = 0.6 g/L)

Note: 0.1 g/L ≈ 0.33 mL/cycle



Rinse aid dispensing amount can be set from 0.0 g/L to 2.0 g/L in 0.1 g/L increments.

- ▶ To increase dosage by 0.1 g/L, press the Menu button
- ▶ To decrease dosage by 0.1 g/L, press the Delime button



To save and exit, either:

- ▶ Press Start Button to move to next item

– Or –

- ▶ Open and close door (Will also exit operator menu)

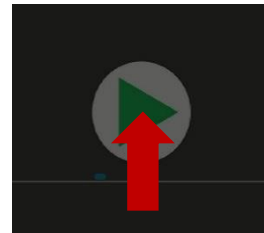

8.6.2 Priming rinse aid dispensing pump

- ▶ Top display shows “05”
 - ↳ Bottom display shows “0”



- ▶ Press the Menu button to change bottom display value to “1”



- ▶ Press delime button to begin rinse aid dispensing pump priming
 - ↳ The rinse aid dispensing pump will activate for 120 seconds
 - ↳ The decimal point in the bottom display will flash while the dispensing pump is on

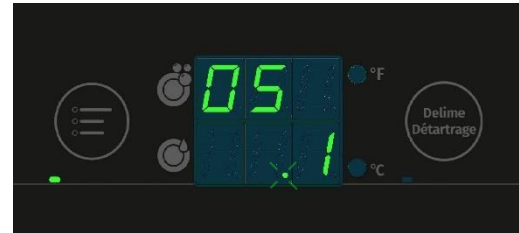

- ▶ Verify the rinse aid is moving from the detergent bottle or container to the machine through the tubing and that there are no air bubbles in the tubing.



↳ Note: The priming process might need to be repeated at least 2 times to fully prime the machine.

To exit the priming menu, either:

- ▶ Press Start Button to move to next item

– Or –

- ▶ Open and close door (Will also exit operator menu and stop priming)

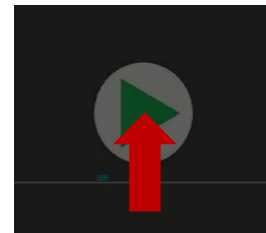

8.6.3 Inspecting rinse aid supply

- ▶ Inspect rinse aid container for chemical present.
- ▶ Verify that the supply tube is correctly inserted with the suction filter at the bottom of the container.
 - ↳ If air bubbles (large gaps) are present in rinse aid line – prime (refer to 8.6.2)

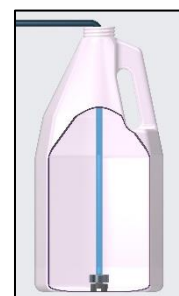

8.6.4 Rinse aid supply level sensor (Optional)

- ▶ Inspect rinse aid container for chemical present.
- ▶ Make sure the bottle level sensor is correctly inserted into container with float sensor at bottom of container.
 - ↳ If air bubbles (large gaps) are present in rinse aid line – prime (refer to 8.6.2)



8.7 Sanitizer dispensing (CUL and EUL machine only)

8.7.1 Setting sanitizer dispensing amount

- ▶ Top display shows “06”
 - ↳ Bottom display shows current sanitizer dispensing setting in % concentration: (default = 50%)



Sanitizer concentration dispensing amount can be set from 20% to 100% in 10% increments.

Sanitizer Dosing Setting

% Concentration	Sodium Hypochlorite Solution (Bleach)		
	5.25%	6.40%	8.40%
	Sanitizer Concentration PPM		
20	15	18	24
30	22	27	36
40	30	37	48
50	37	46	60
60	45	55	72
70	52	64	84
80	60	73	96
90	67	82	108
100	75	91	120

- ▶ To increase dosage, press the Menu button
- ▶ To decrease dosage, press the Delime button

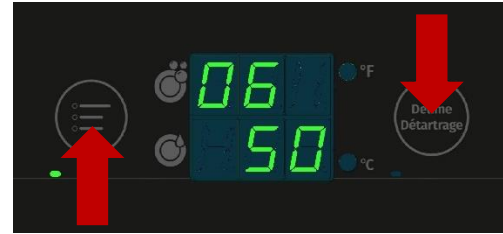

To save and exit, either:

- ▶ Press Start Button to move to next item

– Or –

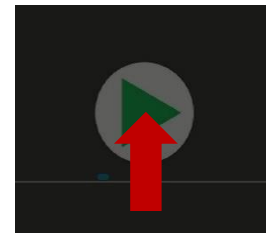

Open and close door (Will also exit operator menu)

8.7.2 Priming sanitizer dispensing pump

⚠ WARNING!



Chemical mixing

Deliming solution must not come in contact with bleach. Mixing may cause hazardous gas to form. Do not prime sanitizer pump while in the delime process.

- ▶ Top display shows “07”
 - ↳ Bottom display shows “0”



- ▶ Press the Menu button to change bottom display value to “1”



- ▶ Press delime button to begin sanitizer dispensing pump priming
 - ↳ The sanitizer dispensing pump will activate for 140 seconds
 - ↳ The decimal point in the bottom display will flash while the dispensing pump is on



CUL machine

- ▶ Verify the sanitizer is moving from the sanitizer bottle or container to the machine through the tubing and that there are no air bubbles in the tubing.



- ↳ Note: The priming process might need to be repeated at least 2 times to fully prime the machine.

EUL machine

- ▶ Verify the sanitizer is moving from the sanitizer bottle or container to the machine through the tubing and that there are no air bubbles in the tubing.

- ↳ When the ball in the sanitizer float sight has moved above the “EMPTY” line, the sanitizer has been fully primed and is ready.
- ↳ Note: The priming process might need to be repeated at least 2 times to fully prime the machine.

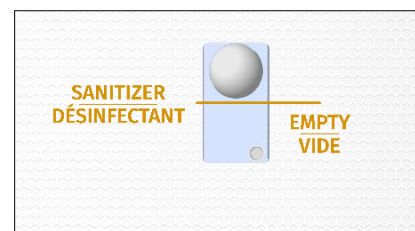

To exit the priming menu, either:

- ▶ Press Start Button to move to next item

– Or –

- ▶ Open and close door (Will also exit operator menu and stop priming)

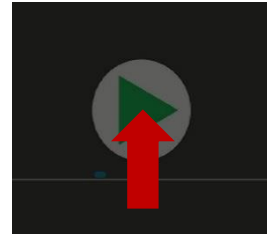

8.7.3 Inspecting sanitizer supply (CUL only)

- ▶ Inspect sanitizer bottle for chemical present.

8.7.4 Inspecting sanitizer supply (EUL only)

- ▶ Verify that the ball in the sanitizer float sight is above the “EMPTY” line.
 - ↳ If the ball is below the “EMPTY” line, inspect the sanitizer container for chemical present.
 - ↳ Prime the sanitizer line if needed (refer to 8.7.2)

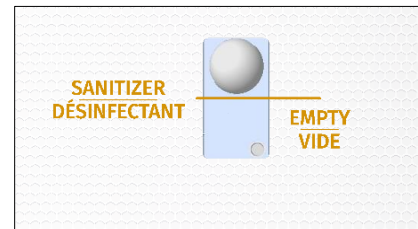

- ▶ Verify that the supply tube is correctly inserted with the suction filter at the bottom of the container.
 - ↳ If air bubbles (large gaps) are present in sanitizer line – prime (refer to 8.7.2)

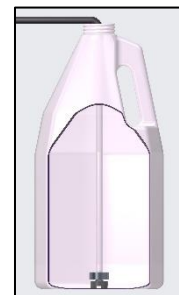

8.7.5 Sanitizer supply level sensor (Optional for EUL)

- ▶ Make sure the bottle level sensor is correctly inserted into bottle with float sensor at bottom of container.
 - ↳ If air bubbles (large gaps) are present in the sanitizer line – prime (refer to 8.7.2)

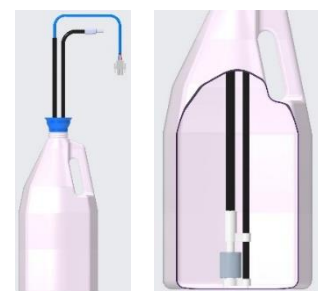

8.8 Temperature display units

- ▶ Top display shows “08”
 - ↳ Bottom display shows current temperature units: (Default is “F”)



- ▶ Press the Menu button or the Delime button to change bottom display to “F” (°F) or “C” (°C)



To exit the temperature units display menu, either:

- ▶ Press Start Button to move to next item

– Or –

- ▶ Open and close door (Will also exit operator menu)

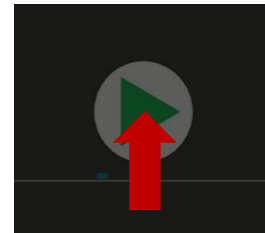

8.9 Aux Channels

– Reserved for Internal Functions –

8.10 Software Version / Machine Program

Display shows the current control software version.

- ▶ Top display shows major version
- ▶ Bottom displays minor revision

Example: Software version 3.5

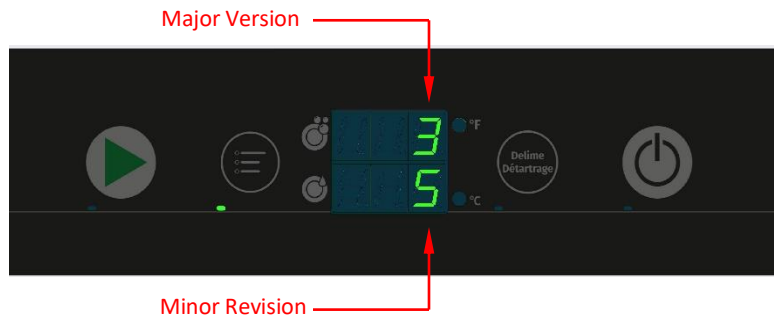

- ▶ Press and hold the Menu button or the Delime button to display the machine program

Example: Machine program 4

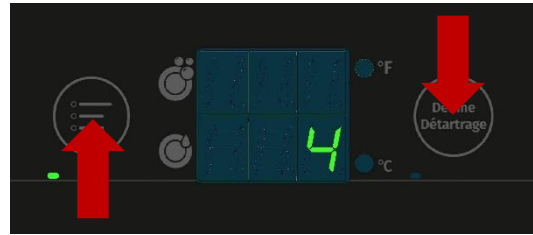

To exit the software version menu, either:

- ▶ Press Start Button to move to next item

– Or –

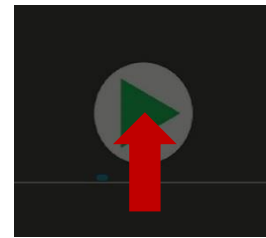

- ▶ Open and close door (Will also exit operator menu)

9 DISPLAY OF ERRORS AND INFORMATION

9.1 Error

- ▶ “Err” appears in the top display.



- ▶ The error code is shown in the bottom display (see table).

*If error code persists, contact Hobart Service 1-888-4HOBART

Error code	Symptom	Possible Solution*
01	Booster Temperature Temperature above upper limit	<ol style="list-style-type: none"> 1. Press the power button to power off (Provide 20 min to cool off). 2. Restart as normal. 3. If error continues to display, possible high limit trip or heating element malfunction – contact Hobart Service.
02	Booster Temperature Temperature below lower limit	<ol style="list-style-type: none"> 1. Press the power button to power off. 2. Restart as normal. 3. If error continues to display, possible high limit trip or heating element malfunction – contact Hobart Service.
03	Rinse Assurance Booster did not meet temperature or water level requirements	<ol style="list-style-type: none"> 1. When booster does not reach temperature or water level set point, a long wash cycle of 10 to 20 minutes will trigger. 2. If error continues to display on next cycle, possible high limit trip or heating element malfunction – contact Hobart Service.

Error code	Symptom	Possible Solution*
05	Wash Tank Temperature Temperature above upper limit	<ol style="list-style-type: none"> 1. Press the power button to power off (Provide 20 min to cool off). 2. Restart as normal. 3. If error continues to display, possible high limit trip or heating element malfunction – contact Hobart Service.
06	Wash Tank Temperature Temperature below lower limit	<ol style="list-style-type: none"> 1. Press the power button to power off. 2. Restart as normal. 3. If error continues to display, possible high limit trip or heating element malfunction – contact Hobart Service.
07	Booster Pressure Level Sensor Voltage above upper limit	<ol style="list-style-type: none"> 1. Press the power button off then on to start the draining process. 2. Drain tank and refill (should reset the pressure level sensors). 3. If error continues to display – contact Hobart Service.
08	Booster Pressure Level Sensor Voltage below lower limit	
09	Wash Tank Pressure Level Sensor Voltage above upper limit	
10	Wash Tank Pressure Level Sensor Voltage below lower limit	
12	Drain Overflow Limit Wash tank water level exceeded limit	<ol style="list-style-type: none"> 1. Verify drain hose is not pinched or kinked. 2. Verify pump strainer is not clogged. 3. If error continues to display, possible drain pump malfunction – contact Hobart Service.
13	Wash Tank Fill Time Exceeded	<ol style="list-style-type: none"> 1. Cycle power button off and then on to continue filling. 2. Check wash and rinse arms for clogged nozzles. 3. If error continues to display – contact Hobart Service.
14	Drain Error – Shutdown Machine took too long to drain	<ol style="list-style-type: none"> 1. Verify drain hose is not pinched, kinked or incorrect drain connection to building drain. 2. Check drain hose for any debris and drain again. 3. If error continue to display – contact Hobart Service.
18	Fill Error – Booster Booster took too long to fill	<ol style="list-style-type: none"> 1. Verify supply hose is not pinched or kinked. 2. Check that water is being supplied to machine. 3. Error will clear once water fills booster to setpoint within set time. 4. If error continues to display, possible fill valve malfunction – contact Hobart Service.
19	Chemical Deficiency Detergent / Rinse Aid / Sanitizer	<ol style="list-style-type: none"> 1. Low or no chemicals. 2. Float level on bottle level sensor below working condition. 3. If no bottle level sensor present, jumpers are missing from chemical level sensor connectors.
do or	Program Interrupted Fill, wash, or delime cycle	<ol style="list-style-type: none"> 1. Machine is in fill, wash or delime cycle. 2. Verify door is closed. 3. If cycle running, then there is a display updating delay.
22	Low Rinse Temperature	<ol style="list-style-type: none"> 1. Rinse temperature below setpoint on 3 consecutive cycles. 2. Error will clear if rinse temperature meets or exceeds setpoint. 3. If error continues to display – contact Hobart Service
24	USB Drive Not Detected	<ol style="list-style-type: none"> 1. USB not properly configured or incorrect directory path. 2. Contact Hobart Service.

Error code	Symptom	Possible Solution*
25	Communication Error	<ol style="list-style-type: none"> 1. Internal communication error 2. Contact Hobart Service.
FIL	Low Water Level at Start of Wash Cycle	<ol style="list-style-type: none"> 1. Check if item(s) from previous wash cycle removed large amount of water from dishwasher. 2. Check orientation of ware to ensure water is not collected. 3. Will automatically correct after starting of the next cycle. 4. Wash tank will fill to proper level and heat to temperature and then wash cycle will resume.
30	Booster Heat Up Time Exceeded at Startup	<ol style="list-style-type: none"> 1. Press the power button to power off and drain tank. 2. Restart as normal. 3. If error continue to display, unplug the machine from the wall. If unit is hardwired, turn circuit breaker off then back on. 4. If error continues to display, possible tripped high limit or heating element malfunction – contact Hobart Service.
31	Fill Error	<ol style="list-style-type: none"> 1. System exceeded maximum fill time. 2. Press the power button to power off machine. 3. Verify supply hose is not pinched or kinked. 4. Check that water is being supplied to machine. 5. Restart as normal. 6. If error continues to display, possible fill valve malfunction – contact Hobart Service.

9.2 Information

► The following notes are displayed with a combination of letters in the display in the display.



Display	Reason	Remedy
do or	Filling, washing draining or delime program interrupted	Close door

10 TROUBLESHOOTING GUIDE

10.1 Poor wash results

Fault Type	Possible Cause	Remedy
Ware not clean	Wash arm hard to turn (must rotate easily by hand).	<ul style="list-style-type: none"> Remove wash arms and clean them thoroughly. Also check that water manifold from machine to wash arm is clear.
	Wash arm nozzles are clogged (visual check).	<ul style="list-style-type: none"> Remove wash arm and rinse wash arm thoroughly until all soiling is removed.
	Rinse nozzles clogged (usually by lime deposit).	<ul style="list-style-type: none"> Remove rinse arms and delime them in separate container. Check building softening system for function. Delime machine if needed.
	Detergent concentration is too low or too high.	Check detergent concentration setting (See operating instructions).
	Tank strainers clogged.	Remove right, left and center strainer pans, empty and clean strainers.
	Pump strainer clogged.	Remove, empty and clean strainer.
	Wrong program selected for heavily soiled wash ware.	Extend the wash program for longer wash cycle.
Ware or glasses dry poorly	Rinse aid concentration too low.	Increase concentration (see operating instructions).
	Wash ware still greasy.	Detergent concentration too low: increase (see operation instructions). Check if detergent is appropriate. If not, choose a stronger one. Drain contaminated water and refill machine. Ensure better pre-scrapping of the wash ware.
	Wash ware left in machine too long after the end of wash cycle.	Remove wash ware as soon as cycle is completed when ware is at its highest temperature to enable better drying.
Streaks and spots on ware or glasses	Rinse aid concentration too high (stripe or bubble formation).	Reduce rinse aid concentration (see operating instructions).
	Hard water or high mineral content.	Check water quality.
	Improper rinse aid	Consult your local chemical provider
	Inadequate rinse aid dispensing causes stains.	Increase rinse aid concentration (see operating instructions).

10.2 Other faults

Fault Type	Possible Causes	Remedy
Glasses are totally or partially cloudy.	Surface of glasses is rough and porous; this is called glass etching.	Use new glasses, this is not caused by a malfunction on the machine.
Glass/dish breakage.	Use of unsuitable dish or glass racks.	Use suitable racks.

11 MAINTENANCE

Genuine spare parts must be used for repairs and maintenance part replacements. Maintenance parts include chemical dispensing tubes, rinse arm bearings, etc.

Contact your Hobart Service office for any repairs or adjustments needed on this equipment. Long-term service contracts are available on this and other Hobart products.

12 DISPOSAL

The machine operator is responsible for disposing of the machine and its operating materials correctly and in accordance with environmental regulations. Observe the national and local regulations.

13 PRODUCT DISCLAIMER

Installations and repairs carried out by non-authorized technicians or using non-genuine spare parts, and any technical alterations to the machine not approved by the manufacturer will invalidate the manufacturer's warranty.

HOBART reserves the right to make changes or improvements to its products without prior notice.

14 NOTES