

# Traulsen & Co., Inc.



Quality Refrigeration

## OWNER'S MANUAL

Instructions for the installation, operation  
and maintenance of all Traulsen:  
R & A Series Convertible Freezer Models

This Traulsen unit is built to our highest quality standards. We build our refrigerators, freezers and heated cabinets this way as a matter of pride. This philosophy has made Traulsen the leader in commercial refrigeration since 1938. We thank you for your choice and confidence in Traulsen equipment and we know you will receive many years of utility from this equipment.

All Traulsen units are placed on a permanent record file with the service department. In the event of any future questions you may have, please refer to the model and serial number found on the name tag affixed to the unit. Should you need service, however, call us on our toll free number, 800-825-8220 between 7:30 am and 4:30 pm CST, Monday thru Friday. It is our pleasure to help and assist you in every possible way.

### INSTALLER

COMPLETE THE FOLLOWING INFORMATION PRIOR TO UNIT INSTALLATION

INITIAL START DATE: \_\_\_\_\_ SERIAL NO. \_\_\_\_\_

MODEL TYPE: \_\_\_\_\_

COMPANY/INDIVIDUAL NAME: \_\_\_\_\_

INSTALLER: \_\_\_\_\_

# TABLE OF CONTENTS

<b>I. THE SERIAL TAG</b>	Page 1	<b>VII. MICROPROCESSOR CONTROL</b>	
<b>II. RECEIPT INSPECTION</b>	Page 2	a-Control Features	Page 5
<b>III. INSTALLATION</b>		b-Control Panel	Page 6
a-Location	Page 2	c-Parts Assembly	Page 6
b-Packaging	Page 2	d-Notes To The User	Page 7
c-Installing Legs or Casters	Page 2	e-Enter The Customer Access Code	Page 7
d-Shelf Pins	Page 2	f-Customer Service Parameters	Page 8
e-Cord & Plug	Page 3	g-Adjusting Thermostat Set Point High	Page 8
f-Power Supply	Page 3	h-Adjusting Thermostat Set Point Low	Page 9
g-Wiring Diagram	Page 3	i-Changing The Temperature Scale	Page 9
h-Clearance	Page 3	j-Setting The 24-Hour Clock	Page 10
<b>IV. OPERATION</b>		k-Setting The Date	Page 11
a-Convertible Cabinets - Intended Use	Page 3	l-Setting Daylight Savings Time	Page 11
b-Convertible Freezer Normal Operation	Page 3	m-Starting A Manual Defrost	Page 12
b-Using The Convertible Freezer	Page 3	n-Setting Defrost Lockouts	Page 13
<b>V. CARE &amp; MAINTENANCE</b>		o-Adjusting The Room Temperature Offset	Page 14
a-Cleaning The Condenser	Page 4	p-Viewing Sensor Temperatures	Page 14
b-Hinge Replacement	Page 4	<b>VIII. TROUBLE SHOOTING GUIDE</b>	Page 15
c-Replacing The Gaskets	Page 4	<b>IX. WARRANTY INFORMATION</b>	Page 16
d-Cleaning The Exterior	Page 5	<b>X. OTHER</b>	
e-Cleaning The Interior	Page 5	a-Service Information	Page 17
<b>VI. MISC. OPERATIONS</b>		b-Spare Parts	Page 17
a-Adjusting The Shelves	Page 5	c-Warranty Registration	Page 17
		<b>XI. PARTS LIST</b>	Page 17
		<b>XII. INDEX</b>	Page 18



FORT WORTH, TX.

<b>SERIAL VOLTS</b>	<b>MODEL Hz</b>	<b>PH</b>	
<b>TOTAL CURRENT</b>	<b>AMPS</b>		
<b>MINIMUM CIRCUIT</b>	<b>AMPS</b>		
<b>MAXIMUM OVERCURRENT PROTECTION</b>			<b>AMPS</b>
<b>LIGHTS</b>	<b>WATTS</b>		
<b>HEATERS</b>	<b>AMPS</b>		
<b>REFRIGERANT DESIGN PRESSURE</b>		<b>TYPE HIGH</b>	<b>OZ LOW</b>
<b>REFRIGERANT DESIGN PRESSURE</b>		<b>TYPE HIGH</b>	<b>OZ LOW</b>

370-60294-00 REV (A)



## I. THE SERIAL TAG

The serial tag is a permanently affixed sticker on which is recorded vital electrical and refrigeration data about your Traulsen product, as well as the model and serial number. This tag is located in the upper right interior compartment on all reach-in/pass-thru and roll-in/roll-thru refrigerator, freezer and dual-temp models. For hot food models, this tag is located on the top of the unit behind the louvers to protect it from the heat.

### READING THE SERIAL TAG

- Serial = The permanent ID# of your Traulsen
- Model = The model # of your Traulsen
- Volts = Voltage
- Hz = Cycle
- PH = Phase
- Total Current = Maximum amp draw
- Minimum Circuit = Minimum circuit ampacity
- Lights = Light wattage
- Heaters = Heater amperage (Hot Food units only)
- Refrigerant = Refrigerant type used
- Design Pressure = High & low side operating pressures and refrigerant charge
- Agency Labels = Designates agency listings

## II. RECEIPT INSPECTION

All Traulsen products are factory tested for performance and are free from defects when shipped. The utmost care has been taken in crating this product to protect against damage in transit. All interior fittings have been carefully secured and the legs or casters are boxed and strapped inside to prevent damage. Door keys will be attached to the handle with a nylon strip. The handle is protected by an easily removable nylon netting.

You should carefully inspect your Traulsen unit for damage during delivery. If damage is detected, you should save all the crating materials and make note on the carrier's Bill Of Lading describing this. A freight claim should be filed immediately. If damage is subsequently noted during or immediately after installation, contact the respective carrier and file a freight claim. Under no condition may a damaged unit be returned to Traulsen & Co. without first obtaining written permission (return authorization).

## III. INSTALLATION

### III. a - LOCATION:

Select a proper location for your Traulsen unit, away from extreme heat or cold. Allow enough clearance between the unit and the side wall in order to make use of the door stay open feature at 120° (self-closing feature operates up to 90°). The door(s) must be able to open a minimum of 90° in order to make use of the maximum clear door width available.

### III. b - PACKAGING:

All Traulsen units are shipped from the factory bolted to a sturdy wooden pallet and packaged in a durable cardboard container. The carton is attached to the wooden skid with the use of large staples. These should first be removed to avoid scratching the unit when lifting off the crate.

Most exterior stainless steel surfaces have a protective vinyl covering to prevent scratching during manufacturing, shipping and installation. After the unit is installed in place of service, remove and discard the covering from all surfaces.

To remove the wooden pallet, first if at all possible, we suggest that the cabinet remain bolted to the pallet during all transportation to the point of final installation. The bolts can then be removed with a 3/4" socket wrench. Avoid laying the unit on its front, side or back for removal of the pallet.

**NOTE:** Traulsen does not recommend laying the unit down on its front, side or back. However, if you must please be certain to allow the unit to remain in an upright position afterwards for 24 hours before plugging it in so that the compressor oils and refrigerant may settle.

## III. INSTALLATION (continued)

### III. c - INSTALLING LEGS OR CASTERS:

6" high stainless steel legs are supplied standard for all Traulsen reach-in and pass-thru units. Casters in lieu of legs are available as an optional accessory for the same models. These are shipped from the factory packed inside a cardboard box which is strapped to one of the shelves. Remove the nylon strap and open the box, it should contain either four (4) legs or four (4) casters and sixteen (16) bolts.

**WARNING: THE CABINET MUST BE BLOCKED AND STABLE BEFORE INSTALLING LEGS OR CASTERS.**

To install the legs or casters, first raise and block the reach-in a minimum of 7" from the floor. For installing legs, thread the legs into the threaded holes on the bottom of the cabinet (see figure 1). Be certain that all legs are tightly secured (legs and casters should be tightened to 300 inch/pounds, max). When the unit is set in its final position, it is important for proper operation that the unit be level. The legs are adjustable for this purpose, turn the bottom of the leg counter-clockwise to raise it, clockwise to lower it. Level the unit from front to back as well as side to side in this manner, using a level placed in the bottom of the cabinet.

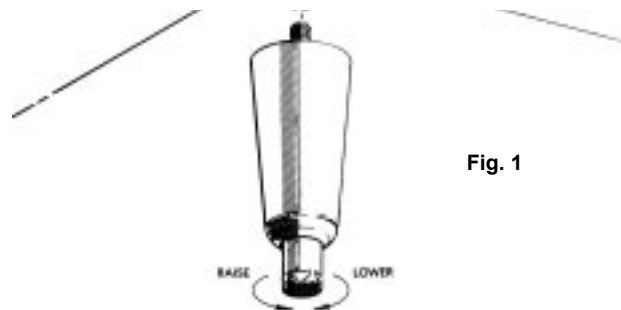

Fig. 1

Please note that Traulsen units are not designed to be moved while on legs. If the unit requires moving, a pallet jack or forklift should be used to prevent damage. For installing casters, the casters are "plate" type, and require the use of four (4) bolts each to secure them firmly to the cabinet bottom at each corner (see figure 2). The caster bolts are tightened using a 1/2" socket wrench.

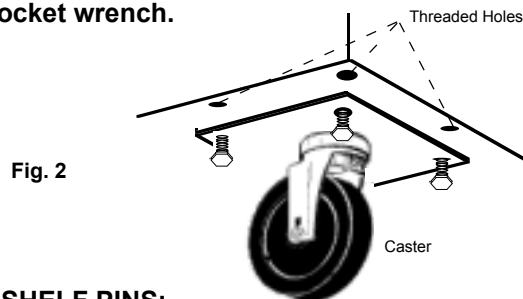

Fig. 2

### III. d - SHELF PINS:

The unit is supplied with shelves and shelf pins installed. Check all shelf pins to assure they are tightened down as they may have come loose during shipping. Rotate the pins clockwise until they are secured against the side of the cabinet.

### III. INSTALLATION (continued)

#### III. e - CORD & PLUG:

Most self-contained models are supplied with a cord & plug attached. It is shipped coiled at the top of the cabinet, secured by a nylon strip. For your safety and protection, all units supplied with a cord and plug include a special three-prong grounding plug on the service cord. Select only a dedicated electrical outlet with grounding plug for power source. **NOTE:** Do not under any circumstances, cut or remove the round grounding prong from the plug, or use an extension cord.

#### III. f - POWER SUPPLY:

The supply voltage should be checked prior to connection to be certain that proper voltage for the cabinet wiring is available (refer to the serial tag to determine correct unit voltage). Make connections in accordance with local electrical codes. Use qualified electricians.

Use of a separate, dedicated circuit is required. Size wiring to handle indicated load and provide necessary overcurrent protector in circuit (see amperage requirements on the unit's serial tag).

#### III. g - WIRING DIAGRAM:

Refer to the wiring diagram for any service work performed on the unit. Should you require one, please contact Traulsen Service at (800) 825-8220, and provide the model and serial number of the unit involved.

#### III. h - CLEARANCE:

In order to assure optimum performance, the condensing unit of your Traulsen unit **MUST** have an adequate supply of air for cooling purposes. Therefore, the operating location must either have a minimum of 12" clearance overhead of the condensing unit or allow for unrestricted air flow at the back of the unit. Clearance of at least 12" above is required in order to perform certain maintenance tasks.

## IV. OPERATION

#### IV. a - CONVERTIBLE CABINET - INTENDED USE:

A convertible cabinet is a reach-in freezer which, with the use of a key switch, can change itself to operate at refrigerated temperatures. This two temperature ability allows the operator to maximize either their refrigerated or frozen storage space as needed, providing them with additional flexibility in order to manage changing menus and product types.

#### IV. b - FREEZER NORMAL OPERATION:

During normal operation, a freezer continuously circulates below freezing cabinet air through the coil. The coil requires a periodic defrosting for proper operation. This is accomplished by an automatic, time activated, temperature/time terminated, defrost program. The controller is preset at the

## IV. OPERATION

#### IV. b - FREEZER NORMAL OPERATION (continued):

factory for six equally spaced defrost cycles within each 24-hour period.

At the start of a freezer defrost cycle, both the compressor and evaporator fans are OFF. The microprocessor control will read "dEF" (see figure 3). The electric heater (attached to the coil) is energized. When a temperature device affixed to the coil senses 70°F (models with electric defrost), the coil is fully defrosted and the compressor operation is resumed, defrost heaters are automatically turned off. The coil fans are delayed from starting at the termination of a defrost cycle. Fan operation is automatically resumed, or they can also be started by a time or temp delay (whichever comes first). In case of temp delay, it uses the same coil sensor and starts at 32°F. The total refrigeration system operation is then resumed.

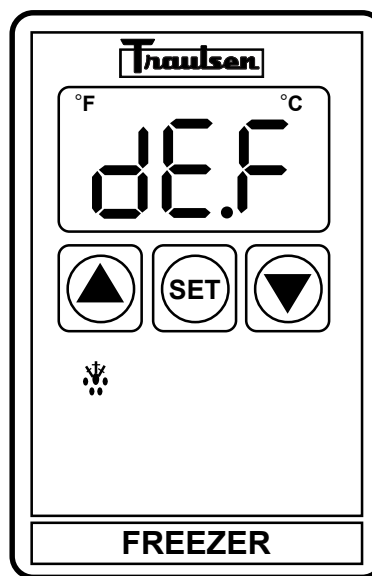

Fig. 3

During freezer defrost operation, heat is confined to the coil enclosure to prevent any significant rise in temperature within the food zone. The fan delay controls function upon termination of a defrost cycle is two-fold. First, to prevent blowing warm air into the food storage area. Second, to prevent any condensation on the defrost coil from being blown into the food storage area.

The Microprocessor control is set from the factory to terminate defrost at 20 minutes in the event of a sensor failure. This setting should never be tampered with, without first consulting the factory.

#### IV. c - USING THE CONVERTIBLE FREEZER:

The default setting as delivered from the factory is for operation in normal freezer mode (0 to -5°F). However, operation can be changed to refrigerated temperatures (36-38°F) by inserting the key into the face mounted "CONVERSION KEY SWITCH" and turning this 90 degrees clockwise. Turn the key back 90 degrees counter-clockwise (to the 12 O'Clock position) to resume normal freezer operation.

## V. CARE & MAINTENANCE

### WARNING:

DISCONNECT ELECTRICAL POWER SUPPLY BEFORE CLEANING ANY PARTS OF THE UNIT.

#### V. a - CLEANING THE CONDENSER:

The most important thing you can do to insure a long, reliable service life for your Traulsen is to regularly clean the condenser coil.

The condensing unit requires regularly scheduled cleaning to keep the finned condenser clean of lint and dust accumulation. Keeping the condenser clean allows the cabinet to operate more efficiently and use less energy.

To clean the condenser, first disconnect electrical power to the cabinet and lift up the front louver assembly. To lift this, remove the two screws located on both sides at the bottom of the louver assembly (see figure 6). Once the screws are removed, the panel can be pivoted upwards allowing full access to the front facing condenser (see figure 7). Vacuum or brush any dirt, lint or dust from the finned condenser coil, the compressor and other cooling system parts. If significant dirt is clogging the condenser fins, use compressed air to blow this clear.

Lower louver assembly and replace the screws to hold it in place.

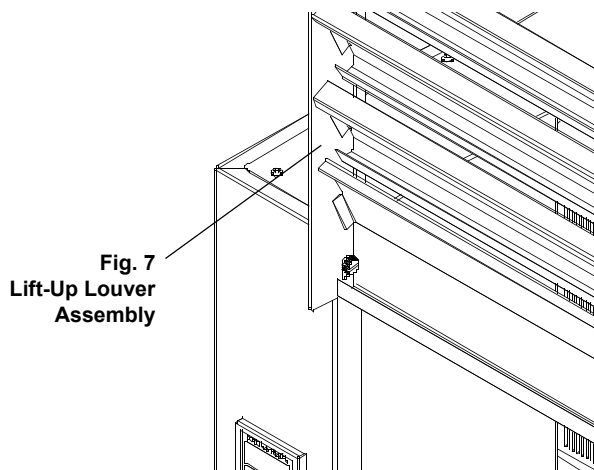
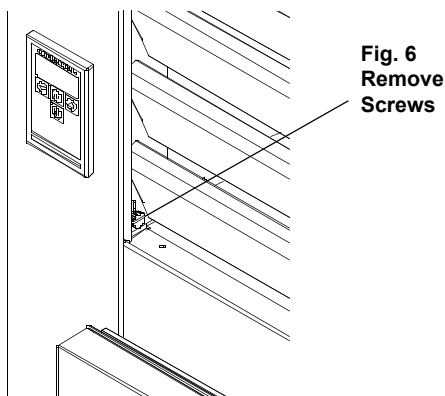

#### V. b - HINGE REPLACEMENT:

Both the door and hinge can be easily removed from the cabinet. To remove the door, remove the plug at the bottom of the top hinge. Inside the hinge there is a small screw which secures the door in place. Remove this with a flat head screwdriver and the door can then be lifted off the hinge. To remove the door portion of the hinge from the door, lift off the hinge cover and then remove the three Phillips head screws which secure the hinge in place on the door. To remove the cabinet portion of the hinge, remove the three Phillips head screws which hold it in place. On solid door units, the top hinge(s) contains a microswitch for controlling the interior lighting.

To reassemble the hinge reverse the previous procedure.

#### V. c - REPLACING THE GASKETS:

To remove the gasket to be replaced, grasp it firmly by one corner and pull it out. Before attempting to install a new gasket, both the unit and the gasket itself must be at room temperature. Insert the four corners first by using a rubber mallet (or hammer with a block of wood). After the corners are properly inserted, work your way towards the center from both ends by gently hitting with a mallet until the gasket is completely seated in place (see figure 8 for proper gasket placement).

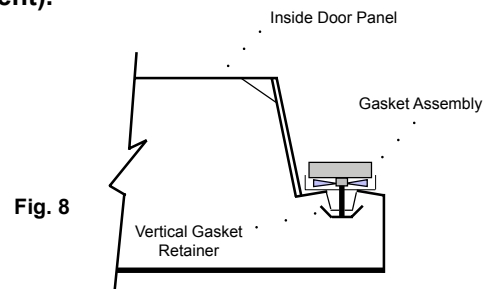

NOTE: The gasket may appear too large, but if it is installed as indicated above it will slip into place.

## V. CARE & MAINTENANCE (cont'd)

### V. d - CLEANING THE EXTERIOR:

Exterior stainless steel should be cleaned with warm water, mild soap and a soft cloth. Apply with a dampened cloth and wipe in the direction of the metal grain.

Avoid the use of strong detergents and gritty, abrasive cleaners as they may tend to mar and scratch the surface. Do NOT use cleansers containing chlorine, this may promote corrosion of the stainless steel.

Care should also be taken to avoid splashing the unit with water, containing chlorinated cleansers, when mopping the floor around the unit.

For stubborn odor spills, use baking soda and water (mixed to a 1 TBSP baking soda to 1 pint water ratio).

### V. e - CLEANING THE INTERIOR:

For cleaning both stainless steel and anodized aluminum interiors, the use of baking soda as described in section "V. d" is recommended. Use on breaker strips as well as door gaskets. All interior fittings are removable without tools to facilitate cleaning.

## VI. MISC. OPERATIONS

### VI. a - ADJUSTING THE SHELVES:

For shelves mounted on pins, first select the desired location and remove the white plastic covers in the interior back and sides by rotating them counter-clockwise. Remove the shelf pins by rotating them counter-clockwise. Install the pins in the desired location by rotating clockwise. Make sure the pin is securely tightened down. Do not over tighten. Slide the shelf into its new position, and replace the white plastic covers into the holes vacated by the shelf pins.



## VII. MICROPROCESSOR CONTROL

Your new Traulsen R or A Series Convertible Refrigerator or Freezer is equipped with an electronic microprocessor control, which precisely regulates operation. It is supplied from the factory completely ready for use. See pages 5 thru 14 for more information.

### VIII. a - MICROPROCESSOR CONTROL FEATURES:

#### Internal Time Clock

- Eliminates defrost time clock (refrigerator and freezer models only).
- Will display only at "Start Up".
- Must be reset after a power failure.
- See "Setting The 24-Hour Clock" on Page 10. (Also required at "Start Up")
- Will automatically update for Daylight Savings Time. See "Setting Daylight Savings Time" on page 11.

#### Water Resistant Housing

The digital controller is water resistant not only from the face of the control, but also from the rear of the housing.

#### Parameter/Service Levels

- See "Customer/Service Parameters" on Page 7 - 8.

#### Defrost Lockouts - See "Setting Defrost Lockouts" on page 13

- Customers can set up to 4 different defrost lockout periods. The lockout prevents the unit from going into a defrost cycle during peak kitchen use. Note: The 24-hour clock must be set for this feature to operate correctly.

## VII. MICROPROCESSOR CONTROL (continued)

### VII. b - CONTROL PANEL:

LED For ° F

3-Digit (red)  
LED Display

Defrost Icon  
With LED

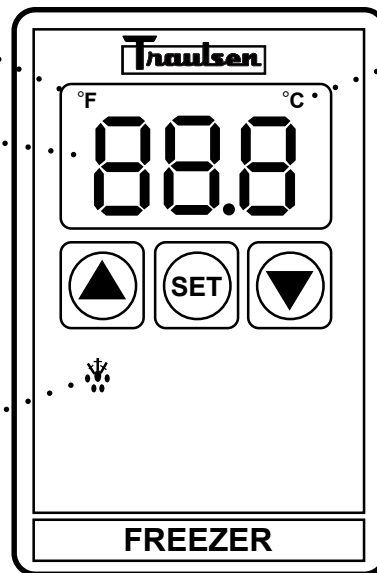

LED For °C

### VII. c - PARTS ASSEMBLY:



COIL SENSOR\*  
337-60071-00



CABINET SENSOR\*  
337-60069-00



HOLDER CLIP\*  
377-60038-00

DEFROST COMPRESSOR  
RELAY POWER LINE IN 2

DOOR HEATER  
EVAP BLOWER RELAY  
POWER LINE IN 1

TRANSFORMER/RS485

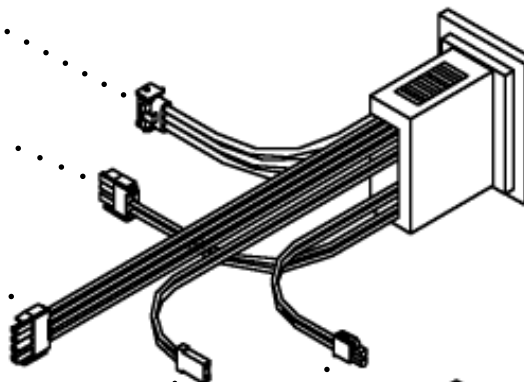

TRAULSEN  
VERTICAL CONTROLLER\*\*  
337-60064-00  
INCLUDES ALL SHOWN

EVAP COIL



HOLDER CLIP

CABINET AIR

\*= Can be ordered separately

\*\*=Requires unit Model No. & S/N to place order.

## VII. MICROPROCESSOR CONTROL (continued)



### VII. d - NOTES TO THE USER:

You only have 20-30 seconds between button pushes. If you take longer than 30 seconds, the controller will revert back to displaying the cabinet temperature. If you enter the wrong security code, the controller will revert back to displaying the cabinet temperature. You can exit the parameters at any time by waiting 20-30 seconds for the control to return to normal operation.

### VII. e - ENTER THE CUSTOMER ACCESS:

This is required to set any of the control parameters.

Use the security code "0, A, 1"  and the following instructions:

Press the set button . The display will read  Customer/Service Access.

Press the set button .

The display will show three zeros with the left zero flashing .

Press the set button .

The display will show three zeros with the center zero flashing .

Press the down arrow key  to sequence through F, E, d, C, b, A, 9, 8, 7,...etc.

When you reach "A" press set .

The display will show "zero, A, zero" with the right zero flashing .

Press the up arrow key  to sequence through 1, 2, 3, 4, 5, 6, 7, 8, 9, A, b,...etc.

When you reach "1" press set .

The display will read  Thermostat Set Point High.













You are now in the **CUSTOMER / SERVICE PARAMETERS.**



## VII. MICROPROCESSOR CONTROL (continued)

### VII. f - CUSTOMER SERVICE PARAMETERS:

Listed below are the available parameters in the order they appear, using the down arrow key on the controller. You can use either the up or down arrow keys to scroll through the options.



	Thermostat Set Point High*		Defrost Lockout 2
	Thermostat Set Point Low		Defrost Lockout 3
	Temperature Scale		Defrost Lockout 4
	Time (24-hour clock)		Room Temperature Offset
	Date (month - day - year)		Evaporator Coil Sensor
	Daylight Savings		
	Start Manual Defrost		
	Defrost Lockout 1		

### VII. g - ADJUSTING THE THERMOSTAT SET POINT HIGH:

This parameter sets the high point of the desired cabinet temperature range. Typically, freezers will range from -3° F to 0° F (-19° C to -18° C) and refrigerators will range from 36° F to 40° F (2° C to 4° C) for this parameter setting. This parameter is preset at the factory and does not have to be adjusted unless the customer chooses to do so. Note: Set Point Low and Set Point High **cannot** be set to the same temperature. There will be at least 1-2 degree difference between the two settings.



Follow the instructions to enter the customer access code on page 7. When the control

display reads  Thermostat Set Point High. Press the set button .

Use the arrow keys   to adjust the temperature to your desired setting.

When the display shows the temperature you want press the set button .

The display will then read  Thermostat Set Point High.

You can use the up or down arrow keys to scroll to the next parameter  



or wait 30 seconds for the control to return to normal operation.

## VII. MICROPROCESSOR CONTROL (continued)



### VII. h - ADJUSTING THE THERMOSTAT SET POINT LOW:

This parameter sets the low point of the desired cabinet temperature range. Typically, freezers will range from -6° F to -4° F (-21° C to -20° C) and refrigerators will range from 32° F to 34° F ( 0° C to 1° C) for this parameter setting. This parameter is preset at the factory and does not have to be adjusted unless the customer chooses to do so. Note: Set Point Low and Set Point High **cannot** be set to the same temperature. There will be at least 1-2 degree difference between the two settings.

Follow the instructions to enter the customer access code on page 7. When the control



displays  Thermostat Set High, press the down arrow key  until the control

display reads  Thermostat Set Point Low. Press the set button .

Use the arrow keys   to adjust the temperature to your desired setting.

When the display shows the temperature you want press the set button .

The display will then read  Thermostat Set Point High.

You can use the up or down arrow keys to scroll to the next parameter  



or wait 30 seconds for the control to return to normal operation.



### VII. i - Changing The Temperature Scale:

The temperature scale determines if the temperature displayed will be in degrees



Fahrenheit or degrees Celsius.

Follow the instructions to enter the customer access code on page 7. When the control

displays  Thermostat Set High, press the down arrow key  until the control

display reads  Temperature Scale. Press the set button .

The display will start with the current setting either  for degrees Fahrenheit

or  for degrees Celsius. Use the arrow keys   to toggle between the options.

When the display shows the scale you want press the set button .

The display will then read  Thermostat Set Point High.

You can use the up or down arrow keys   to scroll to the next parameter

or wait 30 seconds for the control to return to normal operation.



## VII. MICROPROCESSOR CONTROL (continued)



### VII. j - SETTING THE 24-HOUR CLOCK:

The internal timeclock must be set in order for the data storage memory to correctly log events and to allow any defrost lock out to occur at the correct time of day. If the clock is not set, the control assumes the time is 12 a.m. at the time power is supplied to the unit. The hours on a 24-hour timeclock read the following way:



H01 = 1:00 a.m.	H07 = 7:00 a.m.	H13 = 1:00 p.m.	H19 = 7:00 p.m.
H02 = 2:00 a.m.	H08 = 8:00 a.m.	H14 = 2:00 p.m.	H20 = 8:00 p.m.
H03 = 3:00 a.m.	H09 = 9:00 a.m.	H15 = 3:00 p.m.	H21 = 9:00 p.m.
H04 = 4:00 a.m.	H10 = 10:00 a.m.	H16 = 4:00 p.m.	H22 = 10:00 p.m.
H05 = 5:00 a.m.	H11 = 11:00 a.m.	H17 = 5:00 p.m.	H23 = 11:00 p.m.
H06 = 6:00 a.m.	H12 = 12:00 p.m.	H18 = 6:00 p.m.	H24 = 12:00 a.m.

Follow the instructions to enter the customer access code on page 7. When the control

displays  Thermostat Set High, press the down arrow key  until the control



display reads  Clock. Press the set button .

The display will show  Hours. The right two numbers will be flashing.

Use the arrow keys   to set the hour.

When the correct hour is displayed, press the set button .

The display will show  Minutes. The right two numbers will be flashing.

Use the arrow keys to set the minutes  .

When the correct minutes are displayed, press the set button .















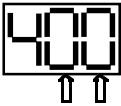

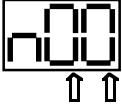

The display will then read  Thermostat Set Point High.

You can use the up or down arrow keys   to scroll to the next parameter

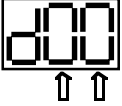









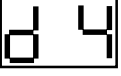

or wait 30 seconds for the control to return to normal operation.

## VII. MICROPROCESSOR CONTROL (continued)

### VII. k - SETTING THE DATE:

The date must be set in order for the data storage memory to correctly log events. Follow the instructions to enter the customer access code on page 7. When the control displays  Thermostat Set Point High, press the down arrow key  until the control display reads  Date. Press the set button . The display will show  (year). The right two numbers will be flashing. Press the arrow keys   to set the year. When the correct year is displayed, press the set button . The display will show  (month). The right two numbers will be flashing. Use the arrow keys   to set the month. When the correct month is displayed, press the set button . The display will show  (day). The right two numbers will be flashing. Press the arrow keys   to set the day. When the correct day is displayed, press the set button . The display will then read  Thermostat Set Point High. You can use the up or down arrow keys   to scroll to the next parameter, or wait 30 seconds for the control to return to normal operation.

### VIII. l - SETTING DAYLIGHT SAVINGS TIME:



This parameter is preset at the factory to automatically adjust the 24-hour clock for Daylight Savings Time. Follow the instructions to enter the customer access code on page 7. When the control displays  Thermostat Set Point High, press the down arrow key  until the display reads  Daylight Savings Time. Press the set button . The display will show  Daylight Savings Time (Yes, automatically adjust for Daylight Savings Time). For "YES," press the set button ; for "NO" press the up or down arrow key  . The display will read  Daylight Savings Time (no). Press the set button . The display will read  Thermostat Set Point High. You can press the the up or down arrow keys   to scroll to the next parameter or wait 30 seconds for the control to return to normal operation.

## VII. MICROPROCESSOR CONTROL (continued)

### VII. m - STARTING A MANUAL DEFROST CYCLE:



This parameter allows a service technician to start a defrost cycle at any time. This parameter will override any lockout settings.

Follow the instructions to enter the customer access code on page 7. When the control

displays  Thermostat Set High, press the down arrow key  until the control display reads  Start Manual Defrost.

Press the set button  .

The display will show  (NO).

Press either arrow key   (YES).

The display will show  .

Press the set button  .

The display will then read  Thermostat Set Point High.

You can use the up or down arrow keys   to scroll to the next parameter

or wait 30 seconds for the control to return to normal operation.

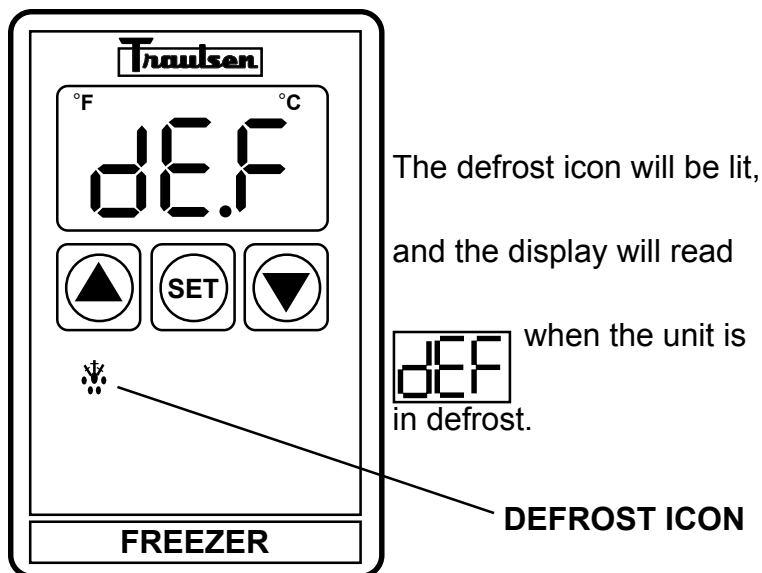

**NOTE:** Traulsen refrigerator units also have an off-cycle defrost once an hour, at which time the control will read  . This defrost is temperature terminated and can last from 3 - 10 minutes (dEF will be displayed for 22-27 minutes).

## VII. MICROPROCESSOR CONTROL (continued)

### VII. n - SETTING THE DEFROST LOCKOUTS:

The defrost lockout parameters allow the customer to prevent the unit from going into a defrost cycle for two hours during a set timeframe. Customers can set up to four defrost lockout parameters. They are all programmed the same way. The parameters will be set for the time the lockout is to start. The controller automatically calculates 2 hours from that setting. The options are similar to the 24-hour clock settings and are in 30-minute increments. Each of the lockout parameters covers 6 hours of the 24-hour clock. Note: The 24-hour clock must be set for this feature to operate at the correct time of day. See "Setting the 24-Hour Clock" on page 10.





OFF

020 = 2:00 a.m.

023 = 2:30 a.m.

030 = 3:00 a.m.

033 = 3:30 a.m.

040 = 4:00 a.m.

043 = 4:30 a.m.

050 = 5:00 a.m.

053 = 5:30 a.m.

060 = 6:00 a.m.

063 = 6:30 a.m.

070 = 7:00 a.m.

073 = 7:30 a.m.

080 = 8:00 a.m.



OFF

080 = 8:00 a.m.

083 = 8:30 a.m.

090 = 9:00 a.m.

093 = 9:30 a.m.

100 = 10:00 a.m.

103 = 10:30 a.m.

110 = 11:00 a.m.

113 = 11:30 a.m.

120 = 12:00 p.m.

123 = 12:30 p.m.

130 = 1:00 p.m.

133 = 1:30 p.m.

140 = 2:00 p.m.



OFF

140 = 2:00 p.m.

143 = 2:30 p.m.

150 = 3:00 p.m.

153 = 3:30 p.m.

160 = 4:00 p.m.

163 = 4:30 p.m.

170 = 5:00 p.m.

173 = 5:30 p.m.

180 = 6:00 p.m.

183 = 6:30 p.m.

190 = 7:00 p.m.

193 = 7:30 p.m.

200 = 8:00 p.m.



OFF

200 = 8:00 p.m.

203 = 8:30 p.m.

210 = 9:00 p.m.

213 = 9:30 p.m.

220 = 10:00 p.m.

223 = 10:30 p.m.

230 = 11:00 p.m.

233 = 11:30 p.m.

240\* = 12:00 a.m.

243\* = 12:30 a.m.

010 = 1:00 a.m.



013 = 1:30 a.m.

020 = 2:00 a.m.



\* Denotes not available.

A lockout cannot be programmed to start at 12:00 a.m. or 12:30 a.m. due to conflicts with other internal programs. The defrost lockouts cannot be programmed to run back-to-back. For example, if dL1 is set to 080, then a defrost cycle would be locked out from 8:00 a.m. to 10:00 a.m. Because of the dL1 setting the dL2 parameter would not let the user choose a lockout start time before 10:30 a.m. All lockouts are preset at the factory to OFF.

Follow the instructions to enter the customer access code on page 7. When the control

displays  Thermostat Set High, press the down arrow key  until the control the

control display reads    or . Press the set button .

The display will show  Off. Press the arrow keys   to set the start time.

When the correct time is displayed, press the set button .

The display will then read  Thermostat Set Point High.

You can press the up or down arrow keys   to scroll to the next parameter

or wait 30 seconds for the control to return to normal operation.

## VII. MICROPROCESSOR CONTROL (continued)



### VII. o - ADJUSTING THE ROOM TEMPERATURE OFFSET:

The room temperature offset parameter allows a service technician or end user the ability to have the display show a temperature that is within three degrees of the actual temperature being read by the cabinet air sensor. This allows for continuity of reading between different temperature reading devices. (i.e.: thermistor Vs thermocouple Vs handheld thermometer) This parameter is preset at the factory to "0" or no offset.

Follow the instructions to enter the customer access code on page 7. When the control displays

 Thermostat Set High, press the down arrow key  until the control display reads 





Room Temperature Offset. Press the set button . Use the arrow keys   to adjust the offset to your desired setting. When the display shows the offset you want press the set button .

The display will then read  Thermostat Set Point High. You can use the up or down arrow keys   to scroll to the next parameter or wait 30 seconds for the control to return to normal operation.

### VII. p - VIEWING SENSOR TEMPERATURES:

These parameters allow a service technician or customer to view the temperature of all sensors within the unit. The temperatures cannot be adjusted.

Follow the instructions to enter the customer access code on page 7. When the control displays

Thermostat Set Point High , press the DOWN arrow key  until the display reads Evaporator Coil Sensor  or Discharge Line Sensor  or press the SET button .

The display will read Thermostat Set Point High .

Press the UP or DOWN arrow keys   to scroll through the parameters or wait 30 seconds for the control to return to normal operation.

## VIII. TROUBLE SHOOTING GUIDE

FIND YOUR PROBLEM HERE	REMEDY
1. Condensing unit fails to start.	<ul style="list-style-type: none"> <li>a. Check if cord &amp; plug has been disconnected.</li> <li>b. Check control temperature setting.</li> </ul>
2. Condensing unit operates for prolonged periods or continuously.	<ul style="list-style-type: none"> <li>a. Are doors closing properly?</li> <li>b. Dirty condenser or filter. Clean properly.</li> <li>c. Evaporator coil iced. Needs to defrost. See instructions for setting a manual defrost cycle on page 12.</li> <li>d. Shortage of refrigerant, call service.</li> </ul>
3. Food compartment is too warm.	<ul style="list-style-type: none"> <li>a. Check door(s) and gasket(s) for proper seal</li> <li>b. Perhaps a large quantity of warm food has recently been added or the door was kept open for a long period of time, in both cases, allow adequate time for the cabinet to recover its normal operating temperature.</li> <li>c. control setting too high, readjust per instructions on page 8.</li> </ul>
4. Food compartment is too cold.	<ul style="list-style-type: none"> <li>a. Perhaps a large quantity of very cold or frozen food has recently been added. Allow adequate time for the cabinet to recover its normal operating temperature.</li> <li>b. Adjust the control to a warmer setting, see page 9.</li> </ul>
5. Condensation on the exterior surface.	<ul style="list-style-type: none"> <li>a. Check door alignment and gaskets for proper seal.</li> <li>b. Condensation on the exterior surface of the unit is perfectly normal during periods of high humidity. However, to alleviate the condition, turn the defogger switch, located below the control, ON/OFF as needed</li> </ul>
6. Compressor hums but does not start.	<ul style="list-style-type: none"> <li>a. Call for service.</li> </ul>
7. Cabinet operating too warm (36 to 38°F) or too cold (0 to -5°F)	<ul style="list-style-type: none"> <li>a. Check conversion key switch for proper operating position.</li> </ul>



## IX. WARRANTY INFORMATION

### STANDARD DOMESTIC WARRANTY

TRAULSEN & CO., INC. warrants new equipment to the original purchaser, when installed within the United States against defective material and workmanship for one (1) year from the date of original installation. Under this warranty, TRAUlsen & CO., INC. will repair or replace, at its option, including service and labor, all parts found to be defective and subject to this warranty. The compressor part is warranted for an additional four (4) years. During this period TRAUlsen & CO., INC. will supply replacement compressor(s) if deemed defective, however, all installation, recharging and repair costs will remain the responsibility of the owner.

**This warranty does not apply to damage resulting from fire, water, burglary, accident, abuse, misuse, transit, acts of God, attempted repairs, improper installation by unauthorized persons, and will not apply to food loss.**

THERE ARE NO ORAL, STATUTORY OR IMPLIED WARRANTIES APPLICABLE TO TRAUlsen, INCLUDING BUT NOT LIMITED TO, ANY IMPLIED WARRANTY OF MERCHANTABILITY OR FITNESS FOR ANY PARTICULAR PURPOSE WHICH EXTEND BEYOND THE DESCRIPTION ON THE FACE HEREOF. TRAUlsen SHALL HAVE NO OBLIGATION OR LIABILITY FOR CONSEQUENTIAL OR SPECIAL DAMAGES, GROWING OUT OF OR WITH RESPECT TO THE EQUIPMENT OR ITS SALE, OPERATION OR USE, AND TRAUlsen NEITHER ASSUMES NOR AUTHORIZES ANYONE ELSE TO ASSUME FOR IT ANY OBLIGATION OR LIABILITY IN CONNECTION WITH THE EQUIPMENT OR ITS SALE, OPERATION OR USE OTHER THAN AS STATED HEREIN.

### INTELA-TRAUL® CONTROL WARRANTY

TRAULSEN & CO., INC. (TRAULSEN), warrants to the original purchaser of the INTELA-TRAUL® control when installed as part of the Refrigeration/Hot Food Equipment manufactured and sold by TRAUlsen, to be free of defects in material and workmanship under normal service and use for a period of two (2) years from the date of installation. Under this warranty statement, TRAUlsen will repair or exchange at TRAUlsen'S discretion, F.O.B. factory, any part of said control, which proves to be defective. Inspection by the TRAUlsen Service Department of parts claimed defective shall be final in determining warranty status. The warranty is to include repair or exchange of any defective In-Warranty control or part(s) of said control for:

Part(s) – Any TRAUlsen INTELA-TRAUL® supplied part(s) found to be defective.

Labor – The labor charges from a TRAUlsen Certified Service Agent to effect the repair or exchange of the defective part(s).

“Defective Part Return” – All claimed defective part(s) must be returned to TRAUlsen for defect validation within 30 days from the date of the repair. Failure to return all claimed defective part(s) to TRAUlsen will invalidate the warranty claim, this warranty statement, and forfeit payment for those repairs effected.

**This warranty does not apply to said equipment or any part thereof which has been subject to misuse, damage in transit, accident, negligence, or alteration, and will not apply if said equipment is located outside The United States.**

### INTERNATIONAL COMMERCIAL WARRANTY

(for Canadian warranties see domestic US warranty)

TRAULSEN & CO., INC. warrants to the original purchaser the Refrigeration Equipment manufactured and sold by it to be free from defects in material and workmanship under normal use and service for a period of one (1) year from date of shipment. Under this warranty, TRAUlsen & CO., INC. will reimburse the purchaser for the replacement of any part of said equipment (excluding dryers & refrigerant gas) which then proves to be defective. This warranty is void if said equipment or any part thereof has been subject to misuse, damage in transit, accident, negligence or alteration.

TRAULSEN'S standard warranty does not apply to Export Sales. Rather, for a period of one (1) year from date of original installation not to exceed Fifteen (15) months from date of shipment from factory, TRAUlsen:

will replace, F.O.B. factory, any defective parts normally subject to warranty.

will not cover the cost of packing, freight or labor such costs being the sole responsibility of the dealer.

**THIS WARRANTY IS IN LIEU OF ALL OTHER WARRANTIES EITHER EXPRESSED OR IMPLIED AND CONSTITUTES TRAUlsen'S FULL OBLIGATION AND LIABILITY. WARRANTIES NOT AVAILABLE ON REMOTE MODELS.**

## X. OTHER

### X. a - SERVICE INFORMATION:

Before calling for service, please check the following:

- Is the electrical cord plugged in?
- Is the fuse OK or circuit breaker on?
- Is the power switch "ON"?

If after checking the above items and the unit is still not operating properly, please contact an authorized Traulsen service agent. A complete list of authorized service agents was provided along with your Traulsen unit. If you cannot locate this, you may also obtain the name of a service agent from the Service/Contact page of our website: [www.traulsen.com](http://www.traulsen.com).

If service is not satisfactory, please contact our in-house service department at:

Traulsen  
4401 Blue Mound Road  
Fort Worth, TX 76106  
(800) 825-8220

Traulsen & Co., Inc. reserves the right to change specifications or discontinue models without notice.

### X. b - SPARE PARTS:

Spare or replacement parts may be obtained through a parts supplier or one of our authorized service agents. A complete list of authorized service agents accompanies this manual and is also posted on our company's official website @ [www.traulsen.com](http://www.traulsen.com).

### X. c - WARRANTY REGISTRATION:

For your convenience, the warranties on your new Traulsen unit may be registered with us by one of two methods. Completing the enclosed warranty card (shipped with the unit).

## XI. PARTS LIST

PART	PART #	DESCRIPTION
Bulb, Fluorescent	337-27690-00	Replacement bulb for fluorescent light models
Bulb, Incandescent	337-29776-00	Replacement bulb for incandescent light models
Bulb Cover	337-30858-00	Replacement bulb cover for incandescent light models
Caster, 6" High	344-13140-01	Optional caster for all reach-in models
Caster, 4" High W/O Brake	SMO-28627-00	Optional lower height caster
Caster, 4" High W/Brake	SMO-28628-00	Optional lower height caster
Caster Bolt (4 req'd per caster)	351-25542-00	Bolt for above
Door Handle, Stainless Steel	344-37690-00	Replacement handle for solid door units
Door Lock, Sliding Glass	346-60005-00	Jewelers type door lock for sliding glass door model
Hinge Cam	344-28488-00	Replacement hinge cam
Hinge Cover	344-28486-00	Replacement hinge cover
Hinge, Spring Assist	SER-29021-03	Alternative hinge, spring assist
Hinge Assembly W/Stop Feature	SER-40677-02	Alternative hinge, stop feature
Hinge Assembly	SER-28583-00	Replacement hinge assembly
Key, Master	346-29467-00	Replacement key for solid door units
Leg, 4" High Adjustable	344-29558-00	Replacement or optional leg
Leg, 6" High Adjustable	344-13168-01	Replacement leg
Shelf Pin	344-24759-00	Replacement shelf pin
Shelf Clip	344-08982-00	Replacement shelf clip for pilasters
Tray Slide, #4 Chrome Rod Type	340-04842-00	Tray slide for rim support of 18" x 26" pan
Tray Slide, Universal	719-07805-00	Tray slide for 18" x 26", 14" x 18" or 12" x 20" pan
Tray Slide, #1	719-20236-00	Tray slide for 18" x 26" or 14" x 18" pan

## XII. INDEX

<b><u>A</u></b>			
<b><u>B</u></b>			
<b><u>C</u></b>			
Cleaning	4, 5		
Casters	2		
Cord & Plug	3		
Clearance	3		
Conversion Key Switch	3		
Customer Access Code	7		
Customer Service Parameters	8		
<b><u>D</u></b>			
Daylight Savings Time	11		
Defrost	3		
Defrost Lockouts	13		
Data Storage	5		
<b><u>E</u></b>			
<b><u>F</u></b>			
<b><u>G</u></b>			
Gaskets	4		
<b><u>H</u></b>			
Hinge	4		
<b><u>I</u></b>			
Internal Time Clock	5		
<b><u>J</u></b>			
<b><u>K</u></b>			
<b><u>L</u></b>			
Legs	2		
Louver Assembly	4		
<b><u>M</u></b>			
Manual Defrost Cycle	12		
<b><u>N</u></b>			
<b><u>O</u></b>			
<b><u>P</u></b>			
Power Supply	3		
<b><u>R</u></b>			
Return Authorization	2		
Room Temperature Offset	14		
<b><u>S</u></b>			
Serial Tag	1		
Shelf Pins	2, 5		
Shelves	2, 5		
Smart Recovery	5		
Smart Defrost	5		
<b><u>T</u></b>			
Thermostat Set Point High	8		
Thermostat Set Point Low	0		
<b><u>U</u></b>			
<b><u>V</u></b>			
Vinyl, Protective Covering	2		
<b><u>W</u></b>			
Warranty	16		
Warranty, Registration	17		
Water Resistant Housing	3		
Wiring Diagram	5		
<b><u>X</u></b>			
<b><u>Y</u></b>			
<b><u>Z</u></b>			

**HOURS OF OPERATION:**

Monday thru Friday 7:30 am - 4:30 pm CST



Quality Refrigeration

**Traulsen**

4401 Blue Mound Road Fort Worth, TX 76106

Phone: (800) 825-8220 Fax-Svce: (817) 740-6757

Website: [www.traulsen.com](http://www.traulsen.com)